

**Haier**  
Inspired living



**Haier**

**2013 R410a General Catalogue**

## Haier Air Conditioning



### ADDRESS

No.1 Haier Road, Hi-tech Zone, Qingdao 266101 P.R.China

### CONTACTS

Tel: +86-532-8893-7182

Website: [www.haier.com](http://www.haier.com)

 The specifications, designs and information in this brochure are subject to the actual products. Haier reserves the right to make change without any notice.

The products are distributed by 

AC-13/EU-Version 1



**2013 General Catalogue R410a**  
**Haier Air Conditioning**

SMARTER LIFE

BETTER PLANET

Version 1

# Haier Group



3 In the marketing network, Haier enjoys an overwhelming competitive edge with "zero distance with end users based on the integration of virtual and physical networks" .

## Global Network Layout of Haier



The "physical networks" include marketing networks, logistics networks and service networks, covering most urban communities and rural markets. Haier has built up more than 7,600 county level stores, 26,000 township stores and 190,000 village-level liaison offices, ensuring that the farmers are informed of "China's Home Appliance Subsidy Program for Rural Areas" within the village, thereby buy these home appliances within the town; Haier has established more than 90 logistics centers in the country and more than 2,000 second-level distribution stations, guaranteeing delivery within 24 hours to the county and within 24 hours to the town, which integrates demand and immediate delivery together and unifies delivery and installation together. Haier has a total of more than

17,000 after-sale service offices in China, among which more than 3,000 are in the first and second level market, more than 4,000 are in the third level market and more than 10,000 township after-sale service stations are built in the fourth level market. This guarantees service-on-call and provides customers a whole set of exquisite and timely door-to-door service with superb technique. Haier's advantage in integration of virtual and physical networks ensures the zero distance between Haier and customers, which not only effectively supports the marketing of Haier products, but also becomes the preferred channel for world-renowned home appliance brands in the Chinese market.

1 Haier Group is the world's leading solution provider to a whole set of home appliance and the distributor through the integration of virtual and physical networks.

Founded in Qingdao in 1984, Haier adheres to the innovation system of centering on customers' needs to drive the sustainable and healthy development. It has grown from a small plant on the verge of bankruptcy into a global group with more than 80,000 employees worldwide and a business turnover of 150.9 billion Yuan in 2011. Its customers cover more than 100 countries and regions around the world.

2 In the white goods field, Haier tops No.1 in the world.

Haier holds some brands closely related to customers' life. According to statistics, Haier has been honored as the world's largest home appliance brand for three consecutive years (data source: Euromonitor). In the Internet era, Haier is committed to creating an open innovation system to support the brand and market development. By 2011 Haier has applied for 12,318 patents or authorized 8,350 patents; Haier has participated in drafting 77 international standards, of which 27 have been promulgated and come into effect, ranking the first among Chinese home appliance industries. Haier has become the worldwide leader of home appliance and the regulation framer in global white goods field.

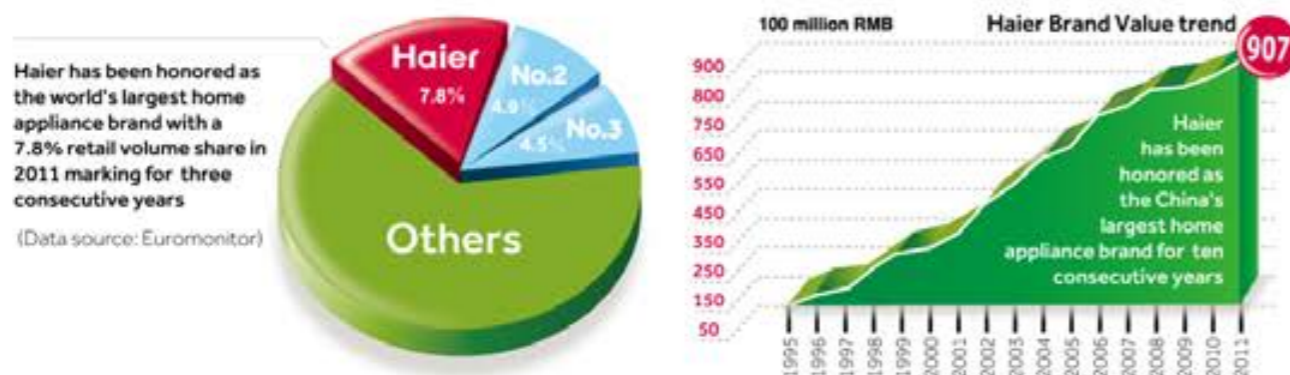

# Haier Group



## 4 Haier is committed to becoming an enterprise of the time.

With its timely strategic innovation and management innovation to adapt to the changing and developing era, Haier has implemented Branding Strategy, Diversification Strategy, International Strategy and Global Brand Strategy, followed by the change of management---TQM, OEC Management, Market Chain Process Reengineering and Win-win Model of Individual-Goal Combination.

## 5 In the internet era, Haier accomplished two strategic transformations: Corporate transformation from "selling products" to "selling services"; Business model transformation from traditional business Model to Win-win Model of Individual-Goal Combination.

Haier's organizational structure adjusts to changing strategies, transforming from traditional "triangle" to "inverted triangle" organization. Thus it forms a flat network organizational structure through the basic self-innovation unit of ZZJYT. Therefore, each employee has to face the market so as to acquire more agilely and quickly and meet the fragmented and personalized needs of customers. The world-renowned business schools and management gurus believe that Haier's Win-win Model of Individual-Goal Combination is disruptive, unprecedented and world advanced. It is a breakthrough to the traditional management theory, and it is possible to crack the management difficulties of the global business field.

## 6 The Win-win Model of Individual-Goal Combination further enhances the profitability and the response speed to customers' needs in the internet era.

From 2007 to 2011 Haier's profit CAGR is 38%, more than two times the income increase. Its cash conversion cycle (CCC) has reached -10 days. Characterized by the internet, the Win-win Model of Individual-Goal Combination is equipped with cross-cultural integration ability. Haier Asia International, established right after the M & A of Sanyo white goods business, the Win-win Model of Individual-Goal Combination has been recognized by the local staff and management team in Japan, and it has attracted local talents to join Haier.

Haier is committed to becoming the leading global brand in the internet era through the innovations of the Win-win Model of Individual-Goal Combination.

# HAIER VISION

## Strategic transformation

Providing solutions for a comfortable home life

People derive limitless inspirational happiness from fresh food, clean cloths, a comfortable environment and nice sunshine, but what they also need in this fast-paced information era are product-based solutions for a comfortable home life. Thus what we at Haier aim to do is to start with the needs of customers and for a more comfortable life for our customers. We are resolute in our commitment to this goal. It is our vision that every time people mention or see "Haier", they are filled with great warmth and happiness.

## THE 50 MOST INNOVATIVE COMPANIES 2010

In April 2010, Business Week of US published The 50 Most Innovative Companies 2010 in the world, which included 5 Chinese companies, and Haier ranked No.28 as the only Chinese home appliances brand.

Rank	Company	Industry	Market Cap (\$B)	Revenue (\$B)	Employees	Headquarters
1	Google	Internet	182	117	23,000	Mountain View, CA
2	Microsoft	Software	145	58	12,000	Redmond, WA
3	Facebook	Internet	100	10	1,000	Foster City, CA
4	Apple	Electronics	100	23	10,000	Cupertino, CA
5	Amazon	Internet	90	19	10,000	Seattle, WA
6	Twitter	Internet	10	1	1,000	San Francisco, CA
7	LinkedIn	Internet	10	1	1,000	Sunnyvale, CA
8	Dropbox	Internet	10	1	1,000	San Francisco, CA
9	Slack	Internet	10	1	1,000	San Francisco, CA
10	Zoom	Internet	10	1	1,000	San Jose, CA
11	IBM	IT	100	100	350,000	Armonk, NY
12	Oracle	Software	100	100	25,000	Redwood City, CA
13	Alibaba Group	Internet	100	100	10,000	Hangzhou, China
14	JD.com	Internet	100	100	10,000	Beijing, China
15	NetEase	Internet	100	100	10,000	Ningbo, China
16	China Mobile	Telecom	100	100	10,000	Beijing, China
17	China Unicom	Telecom	100	100	10,000	Beijing, China
18	China Telecom	Telecom	100	100	10,000	Beijing, China
19	China Railway Group	Transportation	100	100	10,000	Beijing, China
20	China National Petroleum	Energy	100	100	10,000	Beijing, China
21	China National Chemical	Chemicals	100	100	10,000	Beijing, China
22	China National Tobacco	Tobacco	100	100	10,000	Beijing, China
23	China National Salt	Chemicals	100	100	10,000	Beijing, China
24	China National Petroleum	Energy	100	100	10,000	Beijing, China
25	China National Chemical	Chemicals	100	100	10,000	Beijing, China
26	China National Tobacco	Tobacco	100	100	10,000	Beijing, China
27	China National Salt	Chemicals	100	100	10,000	Beijing, China
28	Haier	Home Appliances	100	100	10,000	Laoshan, China
29	Lenovo	IT	100	100	10,000	Beijing, China
30	Lenovo	IT	100	100	10,000	Beijing, China
31	Lenovo	IT	100	100	10,000	Beijing, China
32	Lenovo	IT	100	100	10,000	Beijing, China
33	Lenovo	IT	100	100	10,000	Beijing, China
34	Lenovo	IT	100	100	10,000	Beijing, China
35	Lenovo	IT	100	100	10,000	Beijing, China
36	Lenovo	IT	100	100	10,000	Beijing, China
37	Lenovo	IT	100	100	10,000	Beijing, China
38	Lenovo	IT	100	100	10,000	Beijing, China
39	Lenovo	IT	100	100	10,000	Beijing, China
40	Lenovo	IT	100	100	10,000	Beijing, China
41	Lenovo	IT	100	100	10,000	Beijing, China
42	Lenovo	IT	100	100	10,000	Beijing, China
43	Lenovo	IT	100	100	10,000	Beijing, China
44	Lenovo	IT	100	100	10,000	Beijing, China
45	Lenovo	IT	100	100	10,000	Beijing, China
46	Lenovo	IT	100	100	10,000	Beijing, China
47	Lenovo	IT	100	100	10,000	Beijing, China
48	Lenovo	IT	100	100	10,000	Beijing, China
49	Lenovo	IT	100	100	10,000	Beijing, China
50	Lenovo	IT	100	100	10,000	Beijing, China

## 10 TOP INNOVATIVE COMPANIES

December 22nd, US Newsweek released an article about "10 top innovative company" on its website. Haier was ranked in the 10 top innovative companies in the world.

Rank	Company	Industry
1	Google	Internet
2	Microsoft	Software
3	Facebook	Internet
4	Apple	Electronics
5	Amazon	Internet
6	Twitter	Internet
7	LinkedIn	Internet
8	Dropbox	Internet
9	Slack	Internet
10	Zoom	Internet

# Haier AC



## Haier Air Conditioning

Haier AC provides the solution for comfort and eco air conditioning



**RAC**

Haier Residential air conditioner is China's biggest manufacturing base for Freon-free DC inverter air conditioner.



**CAC**

Commercial air conditioner has China's most complete product categories.



**MHQAC**

Mitsubishi Heavy-Haier is one of the world's strongest enterprises with the most advanced technology in energy saving, environmental protecting and intelligent control.

Haier AC domestic production capacity 20million sets per year



Haier AC overseas production capacity 1.3million sets per year



Haier air conditioner achievements in global markets



**IF** and **ES** awards winner.

Top Supplier for world's NO.1 retailer.

"The Best Buy" in USA.

Winner of the UN purchase order.

Remain NO.1 in Cyprus for 10 years.

The only Chinese self-brand of home appliance in Japan from 2001.

Sponsor for 2008 Beijing Olympic Games.



# Haier AC Milestones



Haier group was founded in Qingdao, China, with a commitment to quality as its cornerstone.

**1984**

**1985**  
Developed China's first split air conditioner.

**1993**  
Developed China's first inverter air conditioner.

Launching China's first dual split inverter conditioner. Start to export air conditioners to Europe market.

**1995**

**1996**  
Launching full range light commercial air conditioning solution.

**1998**  
Launching VRF system with the cooperation with Toshiba, developing the first digital DC inverter air conditioner in the world with healthy function.

**1999**  
Start to export air conditioners to USA and ranked top 3, created record-7000 sets be sold in 7 hours and has been awarded as "the best buy" from 2008.

**2001**  
Founded industry park in Pakistan and rank No.1 M/S in 2005.

**2005**  
Releasing R410A DC inverter X-multi system and got great success in Europe.

**2006**  
Achieving IF design award, one of 10 creative products in the world.

Releasing R410A centrifugal chiller with maglev technology and R410A DC inverter VRF system.

**2007**  
Achieving the bid of 20 projects of Beijing Olympic Games.

Achieving red dot design award.

**2009**

Launching and presenting successfully full range SUPERMATCH range which combine RAC and CAC, inverter and on/off.

**2011**

**2010**  
Introducing the more advanced A+ Freon-free DC inverter air conditioner and magnetically levitated VRF system with highest energy efficiency.

**2012**  
Establish Haier Europe HOMESOLUTION platform at Lyon France to accelerate the marketing of RAC/CAC/Heat pump/Solar solution.



# User Friendly



As Haier we aim to provide solutions for a comfortable life for our customers, we are dedicated to build our organization, planning, R&D investigation and marketing etc. to meet more and more fragmented and detailed requirements from the market. Thus for our air conditioner solution, we focus our efforts offering a more friendly climate to our users, installers, customers and even the earth. With this strategy we invest our global design center located Germany, France, Japan etc. to study more localized needs and ideas from local market, while after this planning investigation China R&D have this first hand information to start developing, testing and training the product/solution coordinating with our local R&D facilities.

## R&D CENTER



USER FRIENDLY as our key strategy which is not only referring to our product planning/developing, but also our marketing/training/service. That means we care our customers.  
For end user, user friendly means energy efficiency, health care, comfortable feeling, easy to use and maintenance etc.  
For installers, user friendly means easy to sell, easy to install, easy to service, easy to get training etc.  
For distributors, user friendly means easy to market, easy to stock, easy to finance etc.



Thus, Haier supermatch solution offer a totally new image of air conditioner which combine residential and commercial, inverter and on/off with the same indoor and outdoor technology, with this solution imagine full range SEER products fulfill the European legislation and saving energy, all fashion design indoor make you more flexible choice for the indoor space, and more important the exclusive SUPERMATCH engineering philosophy give outstanding easy feeling to installers and serviceman, of course we are saving a lot in warehouse space, spare parts and logistics considering the modularized indoor and outdoor.



# Seasonal Efficiency



## Seasonal performance, Haier commits to a landmark change!

With European Legislation looking for drastically cutting energy consumption, improve energy efficiency of building and homes, and meet the commission's targets 20/20/20, industry is looking at more appropriate ways to evaluate efficiency. Thus, the Eco-Design Directive(ERP) aims at reducing the environmental impact of products in the EU. It will introduce a new method for performance specifications- seasonal efficiency- in replacement of the current method of nominal efficiency, which has its limitations.

For Haier, being one of the leaders in the industry to design for optimal seasonal efficiency values, our aim as always is to provide high-performance cooling products that lower the impact on the environment.

### European action plan 20/20/20

 **-20%**  
CO<sub>2</sub> Emissions  
VS.1990

 **+20%**  
Share of  
Renewable Energy

 **-20%**  
Primary Energy  
Use VS. Bau

Aim **2020**

## Nominal VS Seasonal Efficiency

### Temperature



**Nominal:** Temperature condition: 35°C for cooling 7°C for heating, does not often occur in reality

**Seasonal:** Several nation temperatures for cooling and heating, reflecting actual performance over an entire season

### Capacity



**Nominal:** Does not reflect partial capacity, benefits of inverter technology not visible

**Seasonal:** Integrates operation at partial instead of full capacity, benefits of inverter technology are shown

### Auxiliary modes



**Nominal:** Does not take auxiliary power modes into account

**Seasonal:** Includes consumption auxiliary modes, Thermostat off, Standby mode, Off mode, Crankcase heater

### Efficiency



**Nominal:** Efficiency give an indication on how efficient an air conditioner operates at a nominal condition

**Seasonal:** Efficiency gives an indication on how efficient an air conditioner operates over and entire cooling or heating season

## Haier innovate for seasonal efficiency

As a strong and reliable brand in HVAC industry, Haier always focused on energy efficiency solution in global market, as to the current EU new requirement for seasonal efficiency, Haier has put large efforts to meet and even exceed seasonal efficiency criteria.

Start from end 2012, Haier start to launch seasonal efficiency in full range of residential and light commercial air conditioner products which will reach A/A instead of the minimum energy class of D/A.

Moreover Haier continues to innovate and developed in the residential and light commercial range, the new SEASONAL SUPERMATCH range even comply with the EU Eco-Design directives that will only come into force in 2014. These products have improved seasonal efficiency values. This leads

to huge energy savings, lowering the energy bill significantly for apartments, houses, shops, restaurants, offices, small hotels and etc.

Next to its high seasonal performance, the SEASONAL SUPERMATCH range also improve a lot of good features, such as new ZE indoor with lowest noise level, new compact floor ceiling indoor 28K/35K, new simple wired controller and well designed one-body side casing and valve cover of outdoor etc. Considering the no-change indoor in your stock, this solution make you a wonderful management of the warehouse and after sale service.

For more information of SEASONAL SUPERMATCH, please contact your local dealer or visit [www.haier.com](http://www.haier.com).



## The ERP Directive(Eco-Design)

2013 ERP Directive(Eco-Design)

Sets minimum requirements

Defines a better representation of efficiency: SEASONAL EFFICIENCY

Targets lot 10 room air conditioners, local air coolers comfort fans ≤12kW

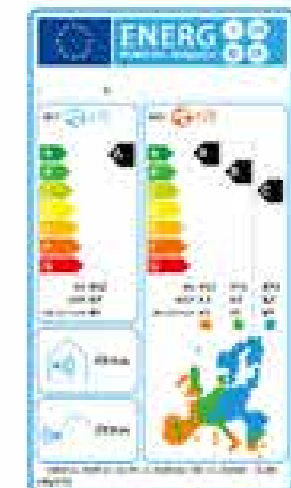

# 2013 New Product



2013 New Product  
**SUPER MATCH**

**NEW**

## 2013 New Product **RESIDENTIAL**

### Zircon Series

- > Nano aqua.
- > Integrated design.
- > 12m air supply.



AS09ZS2ERA Class A+/A  
AS12ZS2ERA Class A+/A  
AS18ZS2ERA Class A+/A

012

### Geos Series

- > Anti-mold filter.
- > Evaporator self-clean.
- > Intelligent air.
- > 3 mins protection.



AS09GN3ERA Class A/A  
AS12GN3ERA Class A/A  
AS18GN3ERA Class A/A

028

### Slim Low ESP Duct AD-SS1ERA

- > 185mm super thin design, which is most advanced in the industry, slimest ceiling drop.
- > 0/30pa selectable ESP. Easy design.
- > DC fan motor design, brings super quiet and super energy efficiency.
- > Universal indoor unit reduce inventory completely.



051

091

### Medium ESP Duct AD-MS1ERA

- > 270mm thin design make the slim ceiling drop.
- > 50Pa ESP fit for difficult design application.
- > 720mm(length)\*650mm(width) fit for compact space to install the air conditioner.
- > Built-in drain pump fit for difficult design application.
- > Universal indoor unit reduce inventory completely.



053

092

### New casing convertible AC-ES1ERA

- > New casing design(L/W/H):1298/700/240(mm), more compact, make installation friendly.
- > 3D air flow, every corner temperature become uniform.
- > Fresh air intake feature brings good healthy for end user.



085

NEW

097

## Single Phase Inverter Outdoor Unit 1U48LS1ERA

- > 12.5kW single phase inverter outdoor unit fit for single phase application.
- > DC fan motor design, brings super quiet and super energy efficiency.
- > Two handles make the carry easily.
- > EEV design, more efficiency.
- > Match with 6 indoor units, fit for different installation applications.



108

## 14kW ON/OFF Outdoor Unit 1U48IS1EAB

- > EEV design make the outdoor unit more efficiency.
- > Match with 6 indoor units, fit for different installation applications.



097

119

## Side Air Inlet Cabinet AP48DS1ERA

- > Side air inlet is different from downside air inlet, the downside panel is new flat-screen appearance & easy clean.
- > LED screen show the temperature & air flow information, end user only to have a glance to read the data.
- > 3D air flow, every corner temperature become uniform.
- > Universal indoor unit reduce inventory completely.



093

114

## Medium ESP Duct AD48NS1ERA

- > 50/100 pa ESP selectable fit for difficult design need.
- > 270mm thin design make the slim selling drop.
- > Universal indoor unit reduce inventory completely.



080

## Single or Three Phase 16kW Inverter Outdoor Unit 1U60IS1ERA/1U60IS1ERB

- > Large capacity 16kW, single or three phase, fit for different installation applications.
- > DC fan motor design, brings super quiet and super energy efficiency.
- > EEV design, more efficiency.



111

## Three Phase 16kW ON/OFF Outdoor Unit 1U60IS1EAB

- > Large capacity 16kW new outdoor unit fit for large space application.
- > EEV design, more efficiency



**NEW**

## 16kW Cassette AB60CS1ERA, PB-1340IB (panel)

080

108

- > 16kW truly large capacity, fit for large space application.
- > Built-in drain pump inside fit for difficult installation application.
- > Universal indoor unit reduce inventory completely.



## 16kW Cabinet AP60KS1ERA

097

119

- > 16kW large capacity fit for large space to get enough cooling/heating.
- > LED screen show the temperature & air flow information, end user only to have a glance to read the data.
- > 3D air flow, every corner temperature become uniform.
- > Universal indoor unit reduce inventory completely.



## 16kW Convertible AC60FS1ERA

084

109

- > 3D airflow, every corner temperature become uniform.
- > Fresh air intake feature brings good healthy for end user.
- > Universal indoor unit reduce inventory completely.



## 6.8kW Multi Split 1:3 3U24GS1ERA

043

- > New 6.8kW one by three outdoor unit fit for big capacity and three rooms air conditioning need.
- > Super high energy efficiency upto SEER A++, advanced in the industry  
**Super installation friendly, care for installer work. Content is below:**
  - > Two handles(left and right) for easy carry.
  - > Parallel wiring & piping connection make easy work.
  - > When start up, PCB programme can check wiring & piping correctness automatically.
  - > Check valve can be used in high/low pressure test, easy for start up and maintenance.
  - > Double 8 screen show failure code in outdoor unit, easy read the data.
  - > On site test software read all indoor unit & outdoor unit running parameter, show parameter curve.



## 16kW High ESP Duct AD60HS1ERA

094

116

- > High 150Pa ESP fit for difficulty design need.
- > ESP can be adjusted from 50pa-150Pa stepless, fit for different ESP installation needs. Save the static pressure box cost for the end user, also save the static pressure box installation for the installer, installation friendly.
- > Universal indoor unit reduce inventory completely.



154

## Side Discharge MRV III-S Outdoor Units

- > Dual frequency 50/60Hz.
- > DC inverter twin rotary compressor.
- > Bldc fan (Brushless DC motor).



15kW 1 Phase  
15kW 3 Phase  
18kW 3 Phase

154

## Side Discharge MRV III-S Outdoor Units

- > Large Capacity Side Discharge Outdoor Units 8/10/12HP.
- > Dual Frequency 50/60Hz.
- > DC inverter twin rotary compressor.
- > Bldc fan ( Brushless DC motor ).
- > Compact design.
- > Easy and efficient installation.

Built in stop valve  
4-way piping is possible ( Front, Rear, Right, Down )



8/10/12HP

155

## T1 Top Discharge MRV III-C Outdoor Units

- > Dual frequency 380-400V/3Ph/50/60Hz.
- > DC inverter scroll compressor.
- > Bldc fan (Brushless DC motor)
- > New basic modular units: 12HP, 14HP, 16HP.
- > Free combination up to 48HP with incremental 2HP, max. indoor units up to 64.



12/14/16HP

163

## 2 Way Cassette

- > Compact design: Only 280mm height.
- > Built in high head drain pump.
- > Ceiling antifouling design: Unique antifouling design.
- > Two way air flow.
- > New stylish design.
- > 5 models ranging from 2.2kW to 5.6kW.



2.2/2.8/3.6/4.5/5.6kW

167

## Floor Ceiling

- > New stylish design for 8.0/9.0kW.
- > Ceiling & Floor installation method.
- > Wide range angle air flow.



8.0/9.0kW

169

## Slim Low Static Pressure Duct

- > 185mm height ultra thin design and 420mm depth.
- > Built in drain pump.
- > Ultra low noise : Realize 21 dB/A operation noise.
- > Rear and bottom air return.
- > Static pressure 0/30Pa.
- > 6 models ranging from 2.2kW to 7.1kW.



2.2/2.8/3.6kW



4.5/5.6/7.1kW

178

## Medium Static Pressure Duct

- > New compact design: Only 270mm height.
- > Built-in drain pump for 5.6/7.1/8.0kW.
- > Flexible duct connection.
- > Static pressure 80/120Pa.



5.6/7.1/8.0kW

186

## Built In Floor Standing Unit

- > Good solution for installation beneath a window.
- > The body is concealed in the cover to get a good decoration effect.
- > High efficiency filter fitted as standard.
- > Require very little installation space: Only 220mm.
- > 6 models ranging from 2.2kW to 7.1kW.



2.2/2.8/3.6/4.5/5.6/7.1 kW

195

## Wired Controller YR-E16

- > **User Friendly-Design**  
4.3 Inch big TFT-LCD screen.
- > **User Friendly-Function**  
Wired control and group control, max. 16 indoor units;  
Built-in weekly timer function.
- > **User Friendly-Installation**  
Push-pull structure:  
Using plug interface to fix the connection wire without screw, easy installation without tools.





# CONTENTS

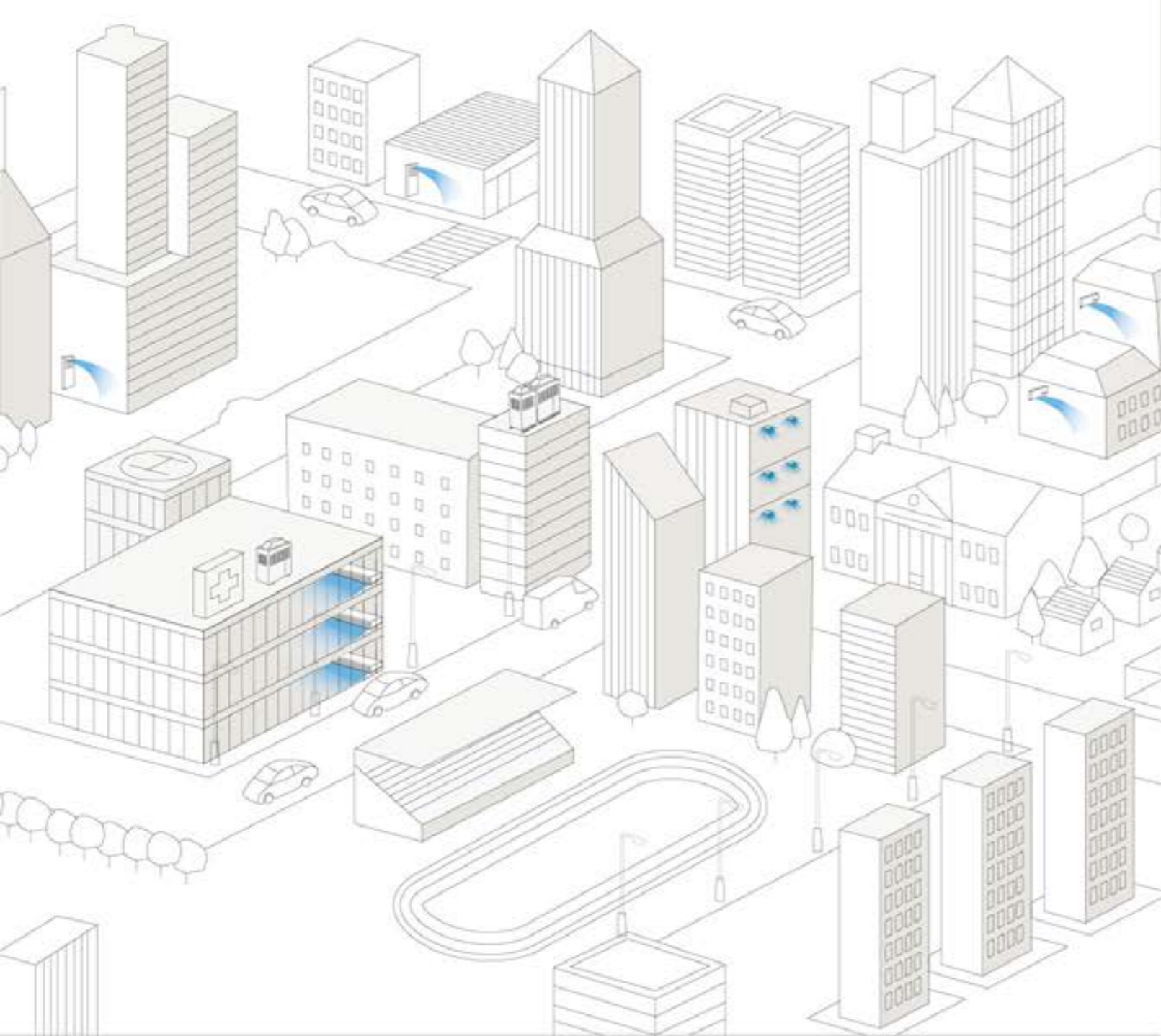

## Status

16 manufacturing bases.  
8 research and developing centers.  
10 research partner institutions.  
46 authorized labs.  
Capacity 21million sets per year.

## Achievements

IF and reddot awards winner.  
Top Supplier for world's NO.1 retailer.  
"The Best Buy" in USA.  
Winner of the UN purchase order.  
Remain NO.1 in Cyprus for 10years.  
The only Chinese self-brand of home appliance in Japan from 2001.  
Sponsor for 2008 Beijing Olympic Games.

001

## RESIDENTIAL

007-DC inverter Super Match  
019-DC Inverter Intelligent Series  
025-DC Inverter Geos Series

029

## SUPER MATCH MULTI

031-Models Line-up  
033-Benefits  
039-Key Feature  
043-Outdoor Units  
045-Indoor Units  
055-Match Table

067

## LIGHT COMMERCIAL DC

069-Models Line-up  
071-Benefits  
073-Key Feature  
075-Specifications

099

## LIGHT COMMERCIAL ON/OFF

101-Models line-up  
103-Benefits  
105-Specifications

121

## MRV III

123-Product Line-up  
127-Benefits  
133-Key Feature  
153-Specifications  
193-Control system  
199-Accessories



<b>Benefits</b>	<b>003</b>
<b>DC Inverter Super Match</b>	<b>007</b>
Aqua Series	<b>009</b>
Zircon Series	<b>011</b>
Home Series	<b>013</b>
Console Series	<b>017</b>
<b>DC Inverter Intelligent Series</b>	<b>019</b>
<b>DC Inverter Geos Series</b>	<b>025</b>

# RESIDENTIAL

## Benefits



SERIES	MODEL	HEALTH										INTELLIGENT & COMFORT															
		Nano-Aqua	Healthy negative ion	HCN healthy module	Bacteria-killing medium	Photocatalyst filter	CAF filter	Vitamin C layer	Anti-mold filter	Negative ion filter	Evaporator self-cleaning	1FEEL U	Super quiet	Extra auto mode	Auto mode	Soft mode	Power mode	On-Off Land	Comfortable sleep	Left & Right airflow	3D comfortable airflow	Intelligent air	3D big fan	Carpet airflow			
Aqua series	AS09QS1ERA	✓		✓	✓	✓		✓	✓	✓			✓	✓		✓	✓	✓	✓	✓	✓	✓	✓	✓			
	1U09BS2ERA	✓		✓	✓	✓		✓	✓	✓			✓	✓		✓	✓	✓	✓	✓	✓	✓	✓	✓	✓		
	AS12QS1ERA	✓		✓	✓	✓		✓	✓	✓			✓	✓		✓	✓	✓	✓	✓	✓	✓	✓	✓	✓		
	1U12BS2ERA	✓		✓	✓	✓		✓	✓	✓			✓	✓		✓	✓	✓	✓	✓	✓	✓	✓	✓	✓		
Zircon series	AS09ZS2ERA		✓	✓	✓	✓	✓	✓	✓	✓			✓	✓	✓	✓	✓	✓	✓	✓	✓	✓	✓	✓	✓	✓	
	1U09BS2ERA		✓	✓	✓	✓	✓	✓	✓	✓			✓	✓	✓	✓	✓	✓	✓	✓	✓	✓	✓	✓	✓	✓	
	AS12ZS2ERA		✓	✓	✓	✓	✓	✓	✓	✓			✓	✓	✓	✓	✓	✓	✓	✓	✓	✓	✓	✓	✓	✓	
	1U12BS2ERA		✓	✓	✓	✓	✓	✓	✓	✓			✓	✓	✓	✓	✓	✓	✓	✓	✓	✓	✓	✓	✓	✓	
	AS18ZS2ERA		✓	✓	✓	✓	✓	✓	✓	✓			✓	✓	✓	✓	✓	✓	✓	✓	✓	✓	✓	✓	✓	✓	✓
	1U18FS2ERA		✓	✓	✓	✓	✓	✓	✓	✓			✓	✓	✓	✓	✓	✓	✓	✓	✓	✓	✓	✓	✓	✓	✓
Home series	AS09GS1ERA				✓	✓	✓	✓	✓	✓	✓	✓	✓	✓	✓	✓	✓	✓	✓	✓	✓	✓	✓	✓	✓	✓	
	1U09BS2ERA				✓	✓	✓	✓	✓	✓	✓	✓	✓	✓	✓	✓	✓	✓	✓	✓	✓	✓	✓	✓	✓	✓	
	AS12GS1ERA				✓	✓	✓	✓	✓	✓	✓	✓	✓	✓	✓	✓	✓	✓	✓	✓	✓	✓	✓	✓	✓	✓	
	1U12BS2ERA				✓	✓	✓	✓	✓	✓	✓	✓	✓	✓	✓	✓	✓	✓	✓	✓	✓	✓	✓	✓	✓	✓	
	AS18GS1ERA				✓	✓	✓	✓	✓	✓	✓	✓	✓	✓	✓	✓	✓	✓	✓	✓	✓	✓	✓	✓	✓	✓	
	1U18FS2ERA				✓	✓	✓	✓	✓	✓	✓	✓	✓	✓	✓	✓	✓	✓	✓	✓	✓	✓	✓	✓	✓	✓	
	AS24GS1ERA				✓	✓	✓	✓	✓	✓	✓	✓	✓	✓	✓	✓	✓	✓	✓	✓	✓	✓	✓	✓	✓	✓	
	1U24GS2ERA				✓	✓	✓	✓	✓	✓	✓	✓	✓	✓	✓	✓	✓	✓	✓	✓	✓	✓	✓	✓	✓	✓	
Console series	AF09AS1ERA				✓	✓	✓	✓	✓	✓	✓	✓	✓	✓	✓	✓	✓	✓	✓	✓	✓	✓	✓	✓	✓	✓	
	1U09BS2ERA				✓	✓	✓	✓	✓	✓	✓	✓	✓	✓	✓	✓	✓	✓	✓	✓	✓	✓	✓	✓	✓	✓	
	AF12AS1ERA				✓	✓	✓	✓	✓	✓	✓	✓	✓	✓	✓	✓	✓	✓	✓	✓	✓	✓	✓	✓	✓	✓	
	1U12BS2ERA				✓	✓	✓	✓	✓	✓	✓	✓	✓	✓	✓	✓	✓	✓	✓	✓	✓	✓	✓	✓	✓	✓	
	AF18AS1ERA				✓	✓	✓	✓	✓	✓	✓	✓	✓	✓	✓	✓	✓	✓	✓	✓	✓	✓	✓	✓	✓	✓	
	1U18FS2ERA				✓	✓	✓	✓	✓	✓	✓	✓	✓	✓	✓	✓	✓	✓	✓	✓	✓	✓	✓	✓	✓	✓	
Intelligent series	AS09SH1ERA		✓	✓	✓	✓	✓	✓	✓	✓	✓	✓	✓	✓	✓	✓	✓	✓	✓	✓	✓	✓	✓	✓	✓	✓	
	1U09EH1ERA		✓	✓	✓	✓	✓	✓	✓	✓	✓	✓	✓	✓	✓	✓	✓	✓	✓	✓	✓	✓	✓	✓	✓	✓	
	AS12SH1ERA		✓	✓	✓	✓	✓	✓	✓	✓	✓	✓	✓	✓	✓	✓	✓	✓	✓	✓	✓	✓	✓	✓	✓	✓	
	1U12EH1ERA		✓	✓	✓	✓	✓	✓	✓	✓	✓	✓	✓	✓	✓	✓	✓	✓	✓	✓	✓	✓	✓	✓	✓	✓	
Geos series	AS09GN3ERA				✓	✓	✓	✓	✓	✓	✓	✓	✓	✓	✓	✓	✓	✓	✓	✓	✓	✓	✓	✓	✓	✓	
	1U09BN2ERA				✓	✓	✓	✓	✓	✓	✓	✓	✓	✓	✓	✓	✓	✓	✓	✓	✓	✓	✓	✓	✓	✓	
	AS12GN3ERA				✓	✓	✓	✓	✓	✓	✓	✓	✓	✓	✓	✓	✓	✓	✓	✓	✓	✓	✓	✓	✓	✓	
	1U12BN2ERA				✓	✓	✓	✓	✓	✓	✓	✓	✓	✓	✓	✓	✓	✓	✓	✓	✓	✓	✓	✓	✓	✓	
	AS18GN3ERA				✓	✓	✓	✓	✓	✓	✓	✓	✓	✓	✓	✓	✓	✓	✓	✓	✓	✓	✓	✓	✓	✓	
	1U18EN2ERA				✓	✓	✓	✓	✓	✓	✓	✓	✓	✓	✓	✓	✓	✓	✓	✓	✓	✓	✓	✓	✓	✓	
	AS09GN3ERA*2				✓	✓	✓	✓	✓	✓	✓	✓	✓	✓	✓	✓	✓	✓	✓	✓	✓	✓	✓	✓	✓	✓	
	2U18FN2ERA				✓	✓	✓	✓	✓	✓	✓	✓	✓	✓	✓	✓	✓	✓	✓	✓	✓	✓	✓	✓	✓	✓	
	AS09GN3ERA+AS12GN3ERA				✓	✓	✓	✓	✓	✓	✓	✓	✓	✓	✓	✓	✓	✓	✓	✓	✓	✓	✓	✓	✓	✓	
2U18FN2ERA				✓	✓	✓	✓	✓	✓	✓	✓	✓	✓	✓	✓	✓	✓	✓	✓	✓	✓	✓	✓	✓	✓		

✓: Standard    ✓: Optional

## Benefits



SERIES	MODEL	CONVENIENT				DESIGN						DESIGN						ENERGY SAVING								
		Auto restart	10°C heating maintenance	3 min protection	24 hours timer	Super match	Original 3D-card lifting panel	Compact design	Integral stop valve cover	Easy clean design	Base pan & drain pan integrative design	Quick & easy installation	2 ways drain piping connection	Electrical deceler	Low ambient cooling	Low ambient heating	Blue fin	Golden fin	High quality element	LED display	"DOUBLE E" display	Large "DOUBLE E" LED display	7-color LED display	Consistent LED display	DC motor	High performance compressor
Aqua series	AS09QS1ERA	✓		✓	✓	✓	✓	✓	✓							✓	✓	✓				✓		✓	✓	✓
	1U09BS2ERA	✓		✓	✓	✓	✓	✓	✓							✓	✓	✓				✓		✓	✓	✓
	AS12QS1ERA	✓		✓	✓	✓	✓	✓	✓							✓	✓	✓				✓		✓	✓	✓
	1U12BS2ERA	✓		✓	✓	✓	✓	✓	✓							✓	✓	✓				✓		✓	✓	✓
Zircon series	AS09ZS2ERA	✓		✓	✓	✓			✓	✓		✓	✓			✓	✓	✓	✓	✓	✓		✓	✓	✓	✓
	1U09BS2ERA	✓		✓	✓	✓			✓	✓		✓	✓			✓	✓	✓	✓	✓	✓		✓	✓	✓	✓
	AS12ZS2ERA	✓		✓	✓	✓			✓	✓		✓	✓			✓	✓	✓	✓	✓	✓		✓	✓	✓	✓
	1U12BS2ERA	✓		✓	✓	✓			✓	✓		✓	✓			✓	✓	✓	✓	✓	✓		✓	✓	✓	✓
	AS18ZS2ERA	✓		✓	✓	✓			✓	✓		✓	✓			✓	✓	✓	✓	✓	✓		✓	✓	✓	✓
1U18FS2ERA	✓		✓	✓	✓			✓	✓		✓	✓			✓	✓	✓	✓	✓	✓		✓	✓	✓	✓	
Home series	AS09GS1ERA	✓		✓	✓	✓			✓	✓						✓	✓	✓	✓	✓	✓		✓	✓	✓	✓
	1U09BS2ERA	✓		✓	✓	✓			✓	✓						✓	✓	✓	✓	✓	✓		✓	✓	✓	✓
	AS12GS1ERA	✓		✓	✓	✓			✓	✓						✓	✓	✓	✓	✓	✓		✓	✓	✓	✓
	1U12BS2ERA	✓		✓	✓	✓			✓	✓						✓	✓	✓	✓	✓	✓		✓	✓	✓	✓
	AS18GS1ERA	✓		✓	✓	✓			✓	✓						✓	✓	✓	✓	✓	✓		✓	✓	✓	✓
	1U18FS2ERA	✓		✓	✓	✓			✓	✓						✓	✓	✓	✓	✓	✓		✓	✓	✓	✓
	AS24GS1ERA	✓		✓	✓	✓			✓	✓						✓	✓	✓	✓	✓	✓		✓	✓	✓	✓
1U24GS2ERA	✓		✓	✓	✓			✓	✓						✓	✓	✓	✓	✓	✓		✓	✓	✓	✓	
Console series	AF09AS1ERA	✓		✓	✓	✓			✓	✓						✓	✓	✓	✓	✓	✓		✓	✓	✓	✓
	1U09BS2ERA	✓		✓	✓	✓			✓	✓						✓	✓	✓	✓	✓	✓		✓	✓	✓	✓
	AF12AS1ERA	✓		✓	✓	✓			✓	✓						✓	✓	✓	✓	✓	✓		✓	✓	✓	✓
	1U12BS2ERA	✓		✓	✓	✓			✓	✓						✓	✓	✓	✓	✓	✓		✓	✓	✓	✓
	AF18AS1ERA	✓		✓	✓	✓			✓	✓						✓	✓	✓	✓	✓	✓		✓	✓	✓	✓
1U18FS2ERA	✓		✓	✓	✓			✓	✓						✓	✓	✓	✓	✓	✓		✓	✓	✓	✓	
Intelligent series	AS09SH1ERA	✓	✓	✓	✓				✓	✓			✓	✓	✓	✓	✓	✓	✓	✓			✓	✓	✓	✓
	1U09EH1ERA	✓	✓	✓	✓				✓	✓			✓	✓	✓	✓	✓	✓	✓	✓			✓	✓	✓	✓
	AS12SH1ERA	✓	✓	✓	✓				✓	✓			✓	✓	✓	✓	✓	✓	✓	✓			✓	✓	✓	✓
	1U12EH1ERA	✓	✓	✓	✓				✓	✓			✓	✓	✓	✓	✓	✓	✓	✓			✓	✓	✓	✓
Geos series	AS09GN3ERA	✓		✓	✓											✓	✓	✓	✓	✓	✓		✓	✓	✓	✓
	1U09BN2ERA	✓		✓	✓											✓	✓	✓	✓	✓	✓		✓	✓	✓	✓
	AS12GN3ERA	✓		✓	✓											✓	✓	✓	✓	✓	✓		✓	✓	✓	✓
	1U12BN2ERA	✓		✓	✓											✓	✓	✓	✓	✓	✓		✓	✓	✓	✓
	AS18GN3ERA	✓		✓	✓											✓	✓	✓	✓	✓	✓		✓	✓	✓	✓
	1U18EN2ERA	✓		✓	✓											✓	✓	✓	✓	✓	✓		✓	✓	✓	✓
	AS09GN3ERA*2	✓		✓	✓											✓	✓	✓	✓	✓	✓		✓	✓	✓	✓
	2U18FN2ERA	✓		✓	✓											✓	✓	✓	✓	✓	✓		✓	✓	✓	✓
AS09GN3ERA+AS12GN3ERA	✓		✓	✓											✓	✓	✓	✓	✓	✓		✓	✓	✓	✓	
2U18FN2ERA	✓		✓	✓											✓	✓	✓	✓	✓	✓		✓	✓	✓	✓	

✓: Standard    ✓: Optional



# Models Line-up



CAPACITY	Aqua	ZIRCON	Home	Console
	 R410A 180° sine wave DC Inverter	 R410A 180° sine wave DC Inverter	 R410A 180° sine wave DC Inverter	 R410A 180° sine wave DC Inverter
9000 Btu/h	AS09QS1ERA 1U09BS2ERA 	AS09ZS2ERA 1U09BS2ERA 	AS09GS1ERA 1U09BS2ERA 	AF09AS1ERA 1U09BS2ERA 
12000 Btu/h	AS12QS1ERA 1U12BS2ERA 	AS12ZS2ERA 1U12BS2ERA 	AS12GS1ERA 1U12BS2ERA 	AF12AS1ERA 1U12BS2ERA 
18000 Btu/h		AS18ZS2ERA 1U18FS2ERA 	AS18GS1ERA 1U18FS2ERA 	AF18AS1ERA 1U18FS2ERA 
24000 Btu/h			AS24GS1ERA 1U24GS1ERA 	

# DC INVERTER SUPER MATCH

# Aqua

## SERIES



180° sine wave  
DC inverter

AS09QS1ERA Class A/A  
AS12QS1ERA Class A/A



Model		AS09QS1ERA 1U09BS2ERA	AS12QS1ERA 1U12BS2ERA
Capacity(W)	Cooling	2550	3500
	Heating	2800	3900
	Pdesign(h(-10°C))	2650	3550
Power input(W)	MAX	1300	1750
	SEER/SCOP(Average)	5.3/3.4	5.4/3.4
Energy label	Cooling/Heating	A/A	A/A
Operating limits(°C)	Cooling	21-35°C(in)/18-46°C(out)	21-35°C(in)/18-46°C(out)
	Heating	10-27°C(in)/-15-24°C(out)	10-27°C(in)/-15-24°C(out)
Running current(A)	MAX	5.8	7.8
Power supply (Ph.V./Hz)		1/230/50	1/230/50
Air circulation (m³/h)		450	500
Moisture removal (10⁻³m³/h)		1.2	1.6
Refrigerant Type		R410A	R410A
Refrigerant pipe	Liquid side diameter(mm)	6.35	6.35
	Gas side diameter(mm)	9.52	9.52
	Max length (m)	15	15
	Max height (m)	10	10
Refrigerant charge (kg)		850	1100
40HTCL (sets)	*just for reference	240	240
<b>Indoor</b>			
Net dimension (mm)	W/D/H	860/175/285	860/175/285
Package dimension (mm)	W/D/H	938/265/360	938/265/360
Net weight (kg)		10	10
Gross weight (kg)		11.7	11.7
Sound power level [dB(A)]	H/Mid/Lo/So	49/44/40/37	50/45/41/38
<b>Outdoor</b>			
Net dimension (mm)	W/D/H	780/245/540	780/245/540
Package dimension (mm)	W/D/H	930/340/614	930/340/614
Net weight (kg)		29	32
Gross weight (kg)		32	35
Sound power level [dB(A)]		60	61

## NANO-AQUA

Do you feel uncomfortable in the dry weather?  
Because your skin are losing moisture!

- > Haier Super Nano-Aqua keeps moisture for you. Its unique Aqua generators can ionize water molecules into nanometer water ion, which can be easily absorbed by skin, keeping moisture anytime.
- > Only the superfine water ion can be absorbed by the horny layer of the skin, moistening skin.

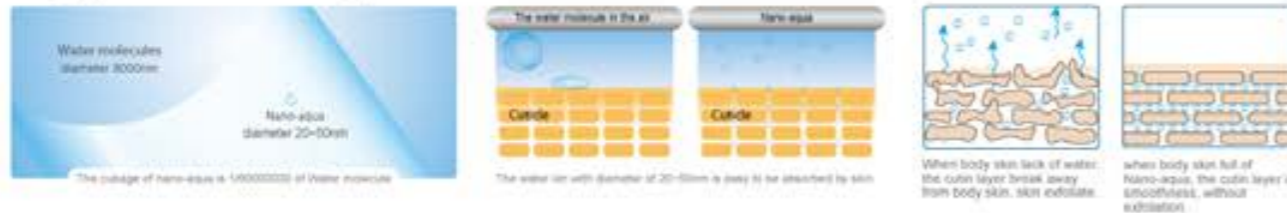

## STYLISH DESIGN THINNEST 158 MM

Dimension 860×175×285mm (W×D×H)



## 7-COLOR LIGHTS CONCEALED LED DISPLAY

7 color lights: Different color represents different running state and function and upon power-off, the display becomes invisible.

Blue--COOL Red--HEAT Light Blue--DRY White--AUTO Orange--FAN Green--NANO-AQUA

Breathing frequency flash: The human-oriented design bases on people's breathing rate(16-18/min), more conducive to sleep.



## ORIGINAL 3D-CANT LIFTING PANEL

Process: Transparent injection molding Spray coating in back.

# ZIRCON SERIES



180° sine wave  
DC inverter

- AS09ZS2ERA Class A+/A
- AS12ZS2ERA Class A+/A
- AS18ZS2ERA Class A+/A

**NEW**



## 12M FAR DISTANCE AIRFLOW

- > Cross flow fan diameter increased to 108mm.
- > Optimized air duct, farther airflow up to 12m.

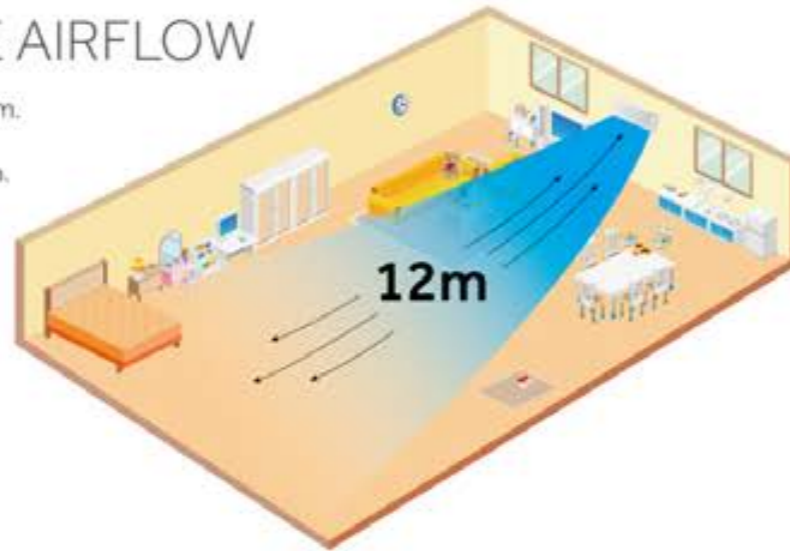

## INTEGRATED DESIGN

Combined base pan and water pan with integrated design for easy installation and maintenance.



## NEGATIVE ION

An Abundance of Natural Negative ions 8,500 to 12,000 ions/cc.

- > Haier Approx. 20,000 ions/cc

Enjoy the feeling of a forest at home. Just press the health button, your room is filled with refreshing ions.

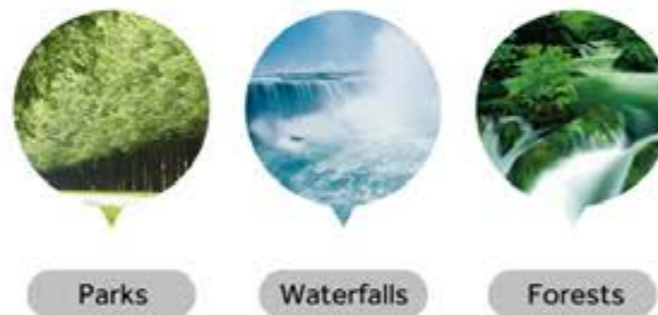

Model		AS09ZS2ERA 1U09BS2ERA	AS12ZS2ERA 1U12BS2ERA	AS18ZS2ERA 1U18FS2ERA
Capacity(W)	Cooling	2630	3500	5200
	Heating	3000	4000	5650
Power input(W)	Pdesign(hl(-10°C))	2700	3700	5200
	MAX	1300	1750	2350
Energy label	SEER/SCOP(Average)	5.8/3.8	5.8/3.8	5.8/3.8
Energy class	Cooling/Heating	A+/A	A+/A	A+/A
Operating limits(°C)	Cooling	21-35°C(in)/18-46°C(out)	21-35°C(in)/18-46°C(out)	21-35°C(in)/18-46°C(out)
	Heating	10-27°C(in)/-15-24°C(out)	10-27°C(in)/-15-24°C(out)	10-27°C(in)/-15-24°C(out)
Running current(A)	MAX	5.8	7.8	10.2
Power supply (Ph.V./Hz)		1/230/50	1/230/50	1/230/50
Air circulation (m³/h)		650	700	900
Moisture removal (10⁻³m³/h)		1.2	1.6	2
Refrigerant Type		R410A	R410A	R410A
Refrigerant pipe	Liquid side diameter(mm)	6.35	6.35	6.35
	Gas side diameter(mm)	9.52	9.52	12.7
	Max length (m)	15	15	25
	Max height (m)	10	10	15
Refrigerant charge (g)		850	1100	1300
40HTFCL (sets)	*just for reference	250	250	160
<b>Indoor</b>				
Net dimension (mm)	W/D/H	798/205/272	798/205/272	960/235/310
Package dimension (mm)	W/D/H	850/257/312	850/257/312	1036/313/375
Net weight (kg)		9	9	11.5
Gross weight (kg)		11	11	13.5
Sound power level [dB(A)]	H/Mid/L/Lo/So	50/45/41/38	51/45/42/39	52/49/45/42
<b>Outdoor</b>				
Net dimension (mm)	W/D/H	780/245/540	780/245/540	810/288/688
Package dimension (mm)	W/D/H	930/340/614	930/340/614	949/406/745
Net weight (kg)		29	32	43
Gross weight (kg)		32	35	45.5
Sound power level [dB(A)]		60	61	63

# Home SERIES



## 180° SINE WAVE DC INVERTER CONTROL TECHNOLOGY (INVERTER TYPE)

The technology of 180° sine DC inverter adjusting speed and vector control is an air conditioner control technology with world leading level which cannot be replaced by 120° control means, and it will become the dominant technology in air conditioner control field.

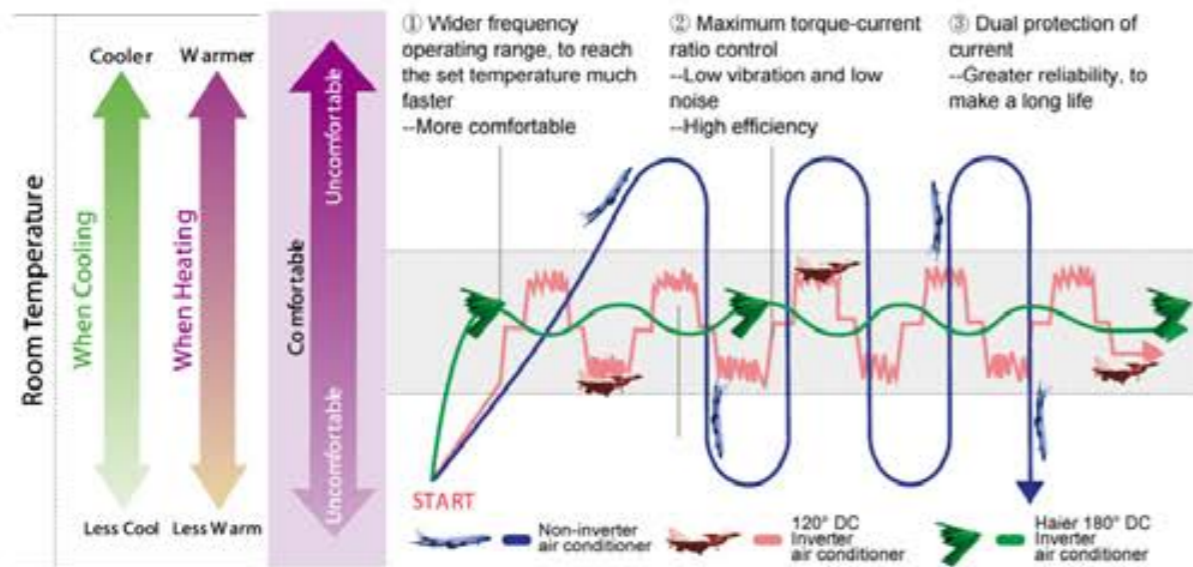

- Lower noise
- Lower vibration
- Longer life
- Higher efficiency

Haier air conditioner with 180° sine wave current DC inverter technology will give you an excellent service for a long long time.

## SIMPLE DESIGN FOR EASY MATCHING

The special designed indoor outlook is easy to match various indoor decoration as it is simple like nature.



## SIMPLE DISPLAY FOR EASY UNDERSTANDING

The "DOUBLE 8" display screen was equipped to show target temperature (When setting) and present temperature (After setting), which is very easy for you to know the indoor temperature situation.



## SIMPLE REMOTE FOR EASY OPERATION

The new designed simple remote controller is only equipped with few clear buttons which can bring us a clear and easy control to the machine working status, forgetting the complicated operation manuals.



## SIMPLE STRUCTURE FOR EASY MAINTENANCE

The optimized structure design can allow us to apply the non-grille front panel which is easy to detach, assemble and wash.



## INTELLIGENT AIR

It adopts the twin air outlet blades technology. According to the person's location in the following diagram, the person is able to select the direction in which the air flows out of the air conditioner, to avoid the air flow directly targeting the body. This prevents people from contracting air conditioning related symptoms.



The airflow is directed upwards during cooling process for fast air-conditioning of the entire room.



The airflow is directed downwards during heating process for fast air-conditioning of the entire room.

# Home SERIES



- AS09GS1ERA Class A/A
- AS12GS1ERA Class A/A



Model		AS09GS1ERA 1U09BS2ERA	AS12GS1ERA 1U12BS2ERA
Capacity(W)	Cooling	2500	3500
	Heating	2600	3850
Power input(W)	Poisign(H-10°C)	2600	3500
	MAX	1300	1750
Energy label	SEER/SCOP(Average)	5.3/3.4	5.3/3.4
Energy class	Cooling/Heating	A/A	A/A
Operating limits(°C)	Cooling	21-35°C(in)/18-46°C(out)	21-35°C(in)/18-46°C(out)
	Heating	10-27°C(in)/-15-24°C(out)	10-27°C(in)/-15-24°C(out)
Running current(A)	MAX	5.8	7.8
Power supply (Ph.V/Hz)		1/230/50	1/230/50
Air circulation (m³/h)		450	500
Moisture removal (10³m³/h)		1.2	1.6
Refrigerant Type		R410A	R410A
Refrigerant pipe	Liquid side diameter(mm)	6.35	6.35
	Gas side diameter(mm)	9.52	9.52
	Max length (m)	15	15
	Max height (m)	10	10
Refrigerant charge (g)		850	1100
40H FCL (sets)	*just for reference	240	240
<b>Indoor</b>			
Net dimension (mm)	W/D/H	795/187/265	795/187/265
Package dimension (mm)	W/D/H	871/304/360	871/304/360
Net weight (kg)		8.8	8.8
Gross weight (kg)		11.3	11.3
Sound power level [dB(A)]	H/Mid/Lo/So	52/47/42/40	53/47/44/41
<b>Outdoor</b>			
Net dimension (mm)	W/D/H	780/245/540	780/245/540
Package dimension (mm)	W/D/H	930/340/614	930/340/614
Net weight (kg)		29	32
Gross weight (kg)		32	35
Sound power level [dB(A)]		62	63



- AS18GS1ERA Class A/A
- AS24GS1ERA Class A/A



Model		AS18GS1ERA 1U18FS2ERA	AS24GS1ERA 1U24GS1ERA
Capacity(W)	Cooling	4900	6400
	Heating	5500	6400
Power input(W)	Poisign(H-10°C)	5100	5200
	MAX	2350	2750
Energy label	SEER/SCOP(Average)	5.1/3.4	5.1/3.4
Energy class	Cooling/Heating	A/A	A/A
Operating limits(°C)	Cooling	21-35°C(in)/18-46°C(out)	21-35°C(in)/18-46°C(out)
	Heating	10-27°C(in)/-15-24°C(out)	10-27°C(in)/-15-24°C(out)
Running current(A)	MAX	10.2	12.3
Power supply (Ph.V/Hz)		1/230/50	1/230/50
Air circulation (m³/h)		850	1100
Moisture removal (10³m³/h)		2	2.8
Refrigerant Type		R410A	R410A
Refrigerant pipe	Liquid side diameter(mm)	6.35	9.52
	Gas side diameter(mm)	12.7	15.88
	Max length (m)	25	25
	Max height (m)	15	15
Refrigerant charge (g)		1300	1550
40H FCL (sets)	*just for reference	170	140
<b>Indoor</b>			
Net dimension (mm)	W/D/H	938/187/265	1046/254/299
Package dimension (mm)	W/D/H	1016/304/360	1126/344/388
Net weight (kg)		10.5	13
Gross weight (kg)		12.5	16.5
Sound power level [dB(A)]	H/Mid/Lo/So	54/51/47/44	57/52/49/46
<b>Outdoor</b>			
Net dimension (mm)	W/D/H	810/288/688	860/308/730
Package dimension (mm)	W/D/H	949/406/745	995/420/815
Net weight (kg)		43	49
Gross weight (kg)		45.5	52
Sound power level [dB(A)]		64	68

# Console SERIES



180° sine wave  
DC Inverter

- AF09AS1ERA Class A/A
- AF12AS1ERA Class A/A
- AF18AS1ERA Class A/A



## EASY INSTALLATION

The indoor units can be installed on the floor or on the wall. It's more flexible and easy for installation.



## AIRFLOW FREE SELECTION

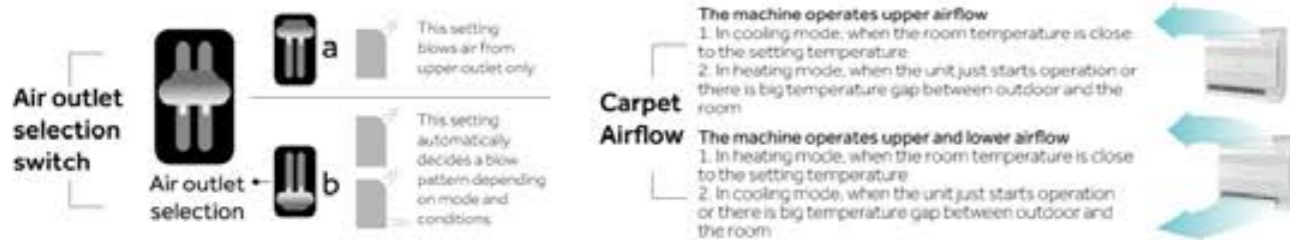

## NEGATIVE ION FILTER



## CARPET AIRFLOW

When switch to two-way airflow mode, the machine would make automatic adjustment for carpet airflow. Under cool mode, for the beginning the wind blows from the upper and lower outlet, and once reaches the setting temperature, the wind will shift to upper airflow. Under heat mode, for the beginning the wind blows from the upper outlet, and once reaches the setting temperature, the wind will shift to upper and lower airflow.

## POWER MODE

When you press a power button once, it will produce more air flow than the high fan speed, cooling the room more faster than ever.

## SLEEP MODE

Press the sleep button, air conditioner will automatically turn the airflow speed down to a lower level, and adjust the temperature timely.

Model		AF09AS1ERA 1U09BS2ERA	AF12AS1ERA 1U12BS2ERA	AF18AS1ERA 1U18FS2ERA
Capacity(W)	Cooling	2500	3500	4900
	Heating	2800	3850	5500
Power input(W)	Pösisgrñ(-10°C)	2600	3500	5100
	MAX	1300	1750	2350
Energy label	SEER/SCOP(Average)	5.3/3.4	5.3/3.4	5.1/3.4
Energy class	Cooling/Heating	A/A	A/A	A/A
Operating limits(°C)	Cooling	21-35°C(in)/18-46°C(out)	21-35°C(in)/18-46°C(out)	21-35°C(in)/18-46°C(out)
	Heating	10-27°C(in)/-15-24°C(out)	10-27°C(in)/-15-24°C(out)	10-27°C(in)/-15-24°C(out)
Running current(A)	MAX	5.8	7.8	10.2
Power supply (Ph, V, Hz)		1/230/50	1/230/50	1/230/50
Air circulation (m³/h)		450	500	800
Moisture removal (l/24h)		1.2	1.6	2
Refrigerant Type		R410A	R410A	R410A
Refrigerant pipe	Liquid side diameter(mm)	6.35	6.35	6.35
	Gas side diameter(mm)	9.52	9.52	9.52
	Max length (m)	15	15	25
	Max height (m)	10	10	15
Refrigerant charge (g)		850	1100	1300
40HTFCL (sets)	*Just for reference	180	180	145
<b>Indoor</b>				
Net dimension (mm)	W/D/H	720/253/640	720/253/640	720/253/640
Package dimension (mm)	W/D/H	784/305/719	784/305/719	784/305/719
Net weight (kg)		17	17.5	17.5
Gross weight (kg)		19.5	20	20
Sound power level [dB(A)]	H/Mid/Low/So	52/50/45/40	53/51/48/42	58/55/51/46
<b>Outdoor</b>				
Net dimension (mm)	W/D/H	780/245/540	780/245/540	810/288/688
Package dimension (mm)	W/D/H	930/340/614	930/340/614	949/406/745
Net weight (kg)		29	32	43
Gross weight (kg)		32	35	45.5
Sound power level [dB(A)]		60	61	64



# DC INVERTER INTELLIGENT series

## Models Line-up



CAPACITY

Nordic **Intelligent** (RS)



AS09SH1ERA

9000 Btu/h



AS12SH1ERA

12000 Btu/h



# Intelligent SERIES



## I FEEL U



This series adopts two intelligent sensors, which could divide a room to 3 sections. By detecting number and location of people in the room it realizes the intelligent control on the air flow. You can freely choose the airflow to follow with your movements or avoid your body through remote setting. In addition, the temperature and air speed can be automatically adjusted according to the number of people and body movements to realize comfort and energy saving.

## HUMANIZED REMOTE CONTROLLER

With the humanized operating concept, the common-use buttons - cooling/heating/IFP/smart are put on the front cover of the remote controller while uncommon-use buttons are separated to be under front cover. This design makes operation more convenient.

This type also has big screen, in which the modes, temperature, airflow speed and direction are all shown clearly, people can get a general idea of the running state by one glance.

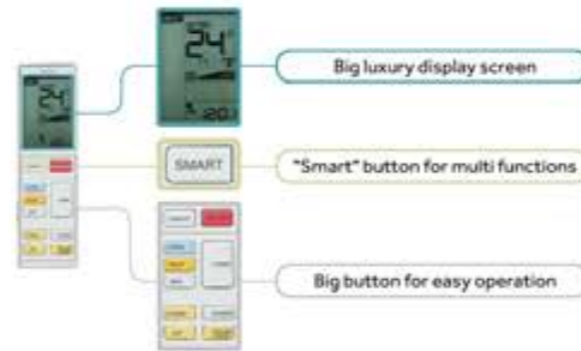

## CONCEALED LED DISPLAY

With the new innovated technology, the unit can indicate the operation status clearly and simply. Exclusively the display turns to be concealed when the unit is off, which creates the stylish and consistent outlook.



## 10° HEATING MAINTENANCE (NORDIC)

For some houses for holiday use, the room would not be occupied for some time. To protect articles from being damaged due to low temperature, the indoor temperature should be kept on a certain level. The heating maintenance function can not only prevent indoor materials from being damaged but also bring comforts to the consumers who can feel the temperature increasing to normal level in a short while back to home.



## SUPER QUIET

Quieter than a whisper - When you press the POWER/SOFT button twice, the indoor unit will operate at a soft quiet 22[dB (A)]. You might not hear it operating which makes it ideal for bedrooms, living rooms, and anyplace you watch television or listen to music.



## SPECIAL DEFROSTING DESIGN (NORDIC)

If the outdoor unit is iced due to the bad weather, Haier air conditioner could automatically clean ice and make unit work normally.

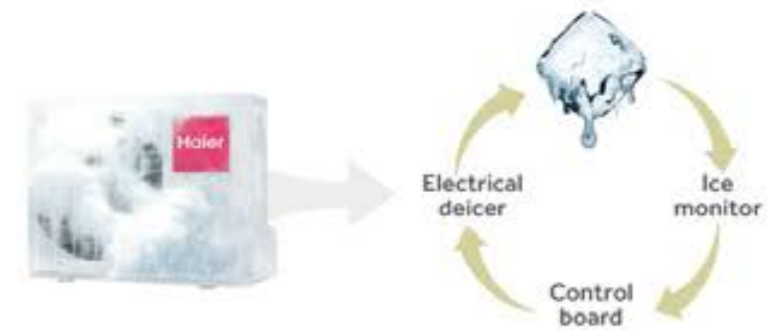

### > Electrical deicer system



Electrical deicer equipped on the compressor which can improve the compressor start-up when cold winter



• New improved electrical heating pipe with higher power up to 135W which can defrost effectively

• New designed bottom plate is much easier to drain

### > New designed refrigerant system



New distribution piping design can highly improve the heat exchanging effectively

### > Special defrosting programme

**Auto defrosting:** The unit will enter defrosting model if its sensor detects the risk of icing.

**Fixed period of defrost:** It can make the units enter defrosting after a fixed period by force, to thaw the ice attached on and around the units. And the ice caused by Nordic sharp heavy snow and ice rain can block units draining but uneasy to feel through outdoor temperature sensor.

# Intelligent SERIES

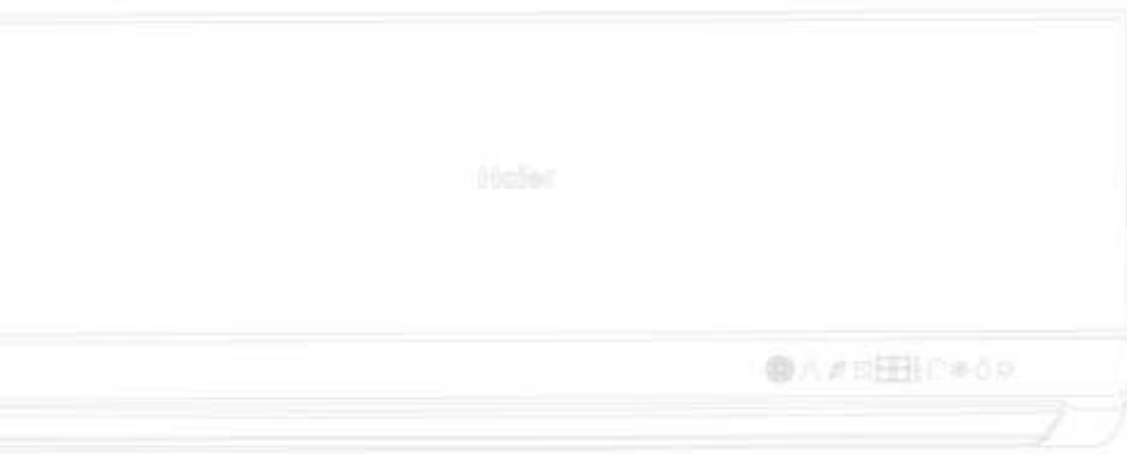

- AS09SH1ERA Class A++/A+
- AS12SH1ERA Class A+/A+



Model		AS09SH1ERA 1U09EH1ERA	AS12SH1ERA 1U12EH1ERA
Capacity(W)	Cooling	2650	3500
	Heating	3620	4300
Power input(W)	Powergrth(-10°C)	3000	3800
	MAX	1450	1850
Energy label	SEER/SCOP(Average)	6.1/4.0	6.1/4.0
Energy class	Cooling/Heating	A++/A+	A+/A+
Operating limits(°C)	Cooling	21-35°C(in)/18-43°C(out)	21-35°C(in)/18-43°C(out)
	Heating	10-27°C(in)/-15-24°C(out)	10-27°C(in)/-15-24°C(out)
Running current(A)	MAX	7.5	9.5
Power supply (Ph,V,Hz)		1/230/50	1/230/50
Air circulation (m³/h)		700	700
Moisture removal (10³m³/h)		1.2	1.6
Refrigerant Type		R410A	R410A
Refrigerant pipe	Liquid side diameter(mm)	6.35	6.35
	Gas side diameter(mm)	12.7	12.7
	Max length (m)	15	15
	Max height (m)	10	10
Refrigerant charge (g)		1050	1050
40°F FCL (sets)	*just for reference	195	195
<b>Indoor</b>			
Net dimension (mm)	W/D/H	800/243/298	800/243/298
Package dimension (mm)	W/D/H	888/335/390	888/335/390
Net weight (kg)		12	12
Gross weight (kg)		14.5	14.5
Sound power level (dB(A))	H/Mid/Lv/So	53/47/40/38	53/47/40/38
<b>Outdoor</b>			
Net dimension (mm)	W/D/H	780/245/640	780/245/640
Package dimension (mm)	W/D/H	930/340/714	930/340/714
Net weight (kg)		34	34
Gross weight (kg)		37	37
Sound power level (dB(A))		61	62



# DC INVERTER GEOS series

## Models Line-up



CAPACITY

**GEOS**



1410A



180° sine wave  
DC inverter



9000 Btu/h

AS09GN3ERA  
1U09BN2ERA



12000 Btu/h

AS12GN3ERA  
1U12BN2ERA



18000 Btu/h

AS18GN3ERA  
1U18BN2ERA



ONE By TWO

2U18FN2ERA



# GEOS SERIES



- AS09GN3ERA Class A/A
- AS12GN3ERA Class A/A
- AS18GN3ERA Class A/A

**NEW**



## HUMANIZED REMOTE CONTROLLER

Intelligent buttons and design let end-users forget complicated operation and feel comfort.

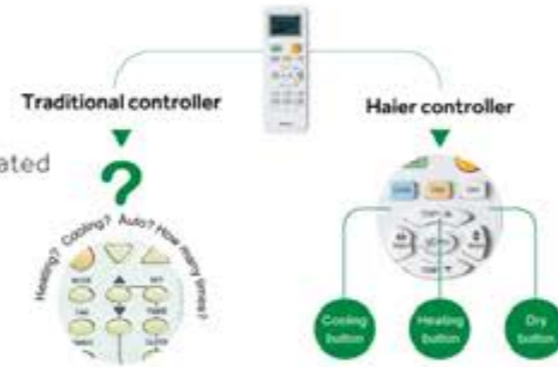

## ANTI-MOLD FILTER

It catches most small dust particles and remove unpleasant odors. It is easily washable.



## ESF FILTER (OPTIONAL)

It eliminates kinds of odors and inactivates harmful chemical gas.



## ESF FILTER & ANTI-MOLD FILTER (OPTIONAL)

It adopts ESF filter and anti-mold filter which can trap harmful dust and remove unpleasant odors effectively purifying the air.

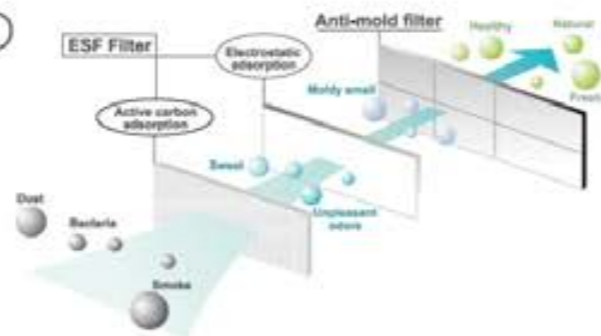

## INTELLIGENT AIR

It adopts the twin air outlet blades technology. According to the person's location in the following diagram, the person is able to select the direction in which the air flows out of the air conditioner, to avoid the air flow directly targeting the body. This prevents people from contracting air conditioning related symptoms.



The airflow is directed upwards during cooling process for fast air-conditioning of the entire room.



The airflow is directed downwards during heating process for fast air-conditioning of the entire room.



Model		AS09GN3ERA 1U09BN2ERA	AS12GN3ERA 1U12BN2ERA	AS18GN3ERA 1U18FN2ERA	AS09GN3ERA AS09GN3ERA 2U18FN2ERA	AS09GN3ERA AS12GN3ERA 2U18FN2ERA
Capacity(W)	Cooling	2300	3300	4800	4600	4700
	Heating	2600	3650	5100	5000	4700
	Reheat(-10°C)	2300	3300	4800	4600	4700
Power input(W)	MAX	1300	1750	2350	2350	2350
	MAX	1300	1750	2350	2350	2350
Energy label	SEER/SCOP(Average)	5.1/3.4	5.1/3.4	5.1/3.4	5.1/3.4	5.1/3.4
Energy class	Cooling/Heating	A/A	A/A	A/A	A/A	A/A
Operating limits(°C)	Cooling	21-35°Cin/18-43°Cout	21-35°Cin/18-43°Cout	21-35°Cin/18-43°Cout	21-35°Cin/18-43°Cout	21-35°Cin/18-43°Cout
	Heating	10-27°Cin/-15-24°Cout	10-27°Cin/-15-24°Cout	10-27°Cin/-15-24°Cout	10-27°Cin/-15-24°Cout	10-27°Cin/-15-24°Cout
Running current(A)	MAX	5.8	7.8	10.2	11.3	11.3
	MAX	5.8	7.8	10.2	11.3	11.3
Power supply (Ph,V,Hz)		1/230/50	1/230/50	1/230/50	1/230/50	1/230/50
Air circulation (m³/h)		400	450	700	400/400	400/450
Moisture removal (L/h)		1.1	1.5	2	1.1/1.1	1.1/1.5
Refrigerant Type		R410A	R410A	R410A	R410A	R410A
Refrigerant pipe	Liquid side diameter(mm)	6.35	6.35	6.35	6.35	6.35
	Gas side diameter(mm)	9.52	9.52	12.7	9.52	9.52
	Max length (m)	15	15	25	20/30	20/30
	Max height (m)	10	10	15	20/30	20/30
Refrigerant charge (kg)		800	1000	1200	1400	1400
40(FCL) sets		240	240	200	140	140
<b>Indoor</b>						
Net dimension (mm)	W/D/H	795/187/265	795/187/265	958/187/265	795/192/265	795/192/265
Package dimension (mm)	W/D/H	871/304/360	871/304/360	1016/304/360	871/304/360	871/304/360
Net weight (kg)		8.8	8.8	10.5	8.8	8.8
Gross weight (kg)		11.3	11.3	12.5	11.3	11.3
Sound power level [dB(A)]	Hr/Mid/Lr/Lo	55/48/43/41	54/48/45/42	55/52/48/45	55/47/45	55/49/47
<b>Outdoor</b>						
Net dimension (mm)	W/D/H	780/245/540	780/245/540	780/245/640	810/288/688	810/288/688
Package dimension (mm)	W/D/H	930/340/614	930/340/614	930/340/714	949/406/745	949/406/745
Net weight (kg)		28	31	35	43.5	43.5
Gross weight (kg)		31	34	35.5	46.5	46.5
Sound power level [dB(A)]		62	63	64	64	64



<b>Models Line-up</b>	<b>031</b>
<b>Benefits</b>	<b>033</b>
<b>Key Feature</b>	<b>039</b>
<b>Outdoor Models</b>	<b>043</b>
<b>Indoor Units</b>	
Aqua Series	<b>045</b>
Zircon Series	<b>046</b>
Home Series	<b>047</b>
Console Series	<b>048</b>
Cassette	<b>049</b>
Convertible	<b>050</b>
Slim Low ESP Duct	<b>051</b>
Low ESP Duct	<b>052</b>
Medium ESP Duct	<b>053</b>
<b>Control system</b>	<b>054</b>
<b>Match Table</b>	<b>055</b>

# SUPER MATCH MULTI

# Models Line-up



Indoor unit series		7000 Btu/h	9000 Btu/h	12000 Btu/h	18000 Btu/h	24000 Btu/h		
Aqua series 		AS07QS1ERA	AS09QS1ERA	AS12QS1ERA				
Zircon series 		AS07ZS2ERA	AS09ZS2ERA	AS12ZS2ERA	AS18ZS2ERA			
Home series 		AS07GS1ERA	AS09GS1ERA	AS12GS1ERA	AS18GS1ERA	AS24GS1ERA		
Console series 			AS09AS1ERA	AF12AS1ERA	AF18AS1ERA			
Cassette 			AB09CS1ERA	AB12CS1ERA	AB18CS1ERA	AB24ES1ERA		
Convertible 				AC12CS1ERA	AC18CS1ERA	AC24CS1ERA		
Slim low ESP duct 			AD09SS1ERA	AD12SS1ERA	AD18SS1ERA	AD24SS1ERA		
Low ESP duct 			AD09LS1ERA	AD12LS1ERA	AD18LS1ERA	AD24LS1ERA		
Medium ESP duct 				AD12MS1ERA	AD18MS1ERA	AD24MS1ERA		
Outdoor unit series		14000 Btu/h - 4.1 kW	18000 Btu/h - 5.1 kW	19000 Btu/h - 5.4 kW	24000 Btu/h - 6.8 kW	26000 Btu/h - 7.6 kW	30000 Btu/h - 8.8 kW	34000 Btu/h - 10 kW

# Benefits



SERIES	MODEL	HEALTH										INTELLIGENT & COMFORT												
		Nano-Aqua	Healthy negative ion	ICD healthy module	Bacteria-kill medium	Photocatalyst filter	ESF filter	Vitamin-C layer	Anti-mold filter	Negative ion filter	Evaporator self-cleaning	Super quiet	Entire auto mode	Auto mode	Soft mode	Power mode	On-Off card	Comfortable sleep	Left & Right airflow	3D comfortable airflow	Intelligent air	3D big fan	Carpet airflow	
Aqua series	AS07QS1ERA	✓		✓	✓	✓		✓	✓		✓	✓	✓		✓	✓		✓	✓	✓	✓			
	AS09QS1ERA	✓		✓	✓	✓		✓	✓		✓	✓		✓	✓		✓	✓	✓	✓	✓			
	AS12QS1ERA	✓		✓	✓	✓		✓	✓		✓	✓		✓	✓		✓	✓	✓	✓	✓			
Zircon series	AS07ZS2ERA		✓	✓	✓	✓	✓		✓		✓	✓		✓	✓	✓	✓						✓	
	AS09ZS2ERA		✓	✓	✓	✓	✓		✓		✓	✓		✓	✓	✓	✓						✓	
	AS12ZS2ERA		✓	✓	✓	✓	✓		✓		✓	✓		✓	✓	✓	✓						✓	
	AS18ZS2ERA		✓	✓	✓	✓	✓		✓		✓	✓		✓	✓	✓	✓						✓	
Home series	AS07GS1ERA				✓	✓	✓		✓	✓	✓		✓	✓	✓	✓	✓					✓		
	AS09GS1ERA				✓	✓	✓		✓	✓	✓		✓	✓	✓	✓	✓					✓		
	AS12GS1ERA				✓	✓	✓		✓	✓	✓		✓	✓	✓	✓	✓					✓		
	AS18GS1ERA				✓	✓	✓		✓	✓	✓		✓	✓	✓	✓	✓					✓		
	AS24GS1ERA				✓	✓	✓		✓	✓	✓		✓	✓	✓	✓	✓					✓		
Console series	AF09AS1ERA				✓	✓	✓		✓	✓	✓		✓	✓	✓	✓	✓							✓
	AF12AS1ERA				✓	✓	✓		✓	✓	✓		✓	✓	✓	✓	✓							✓
	AF18AS1ERA				✓	✓	✓		✓	✓	✓		✓	✓	✓	✓	✓							✓

✓: Standard    ✓: Optional

# Benefits



SERIES	MODEL	CONVENIENT			DESIGN					DESIGN										ENERGY SAVING			
		Auto restart	3 min protection	24 hours timer	Super match	Original 3D-cant lifting panel	Compact design	Integral stop valve cover	Easy clean design	Base pan & drain pan adjustable	Quick & easy installation	2 ways drain piping connection	Blue fn	Golden fn	High quality element	LED display	"DOUBLE E" display	Large "DOUBLE E" LED display	7-color LED display	Controlled LED display	DC motor	High performance compressor	180° sine wave DC inverter
Aqua series	AS07QS1ERA	✓	✓	✓	✓	✓	✓							✓	✓	✓			✓		✓	✓	✓
	AS09QS1ERA	✓	✓	✓	✓	✓	✓							✓	✓	✓			✓		✓	✓	✓
	AS12QS1ERA	✓	✓	✓	✓	✓	✓							✓	✓	✓			✓		✓	✓	✓
Zircon series	AS07ZS2ERA	✓	✓	✓	✓				✓	✓		✓	✓	✓	✓	✓	✓		✓	✓	✓	✓	✓
	AS09ZS2ERA	✓	✓	✓	✓				✓	✓		✓	✓	✓	✓	✓	✓		✓	✓	✓	✓	✓
	AS12ZS2ERA	✓	✓	✓	✓				✓	✓		✓	✓	✓	✓	✓	✓		✓	✓	✓	✓	✓
	AS18ZS2ERA	✓	✓	✓	✓				✓	✓		✓	✓	✓	✓	✓	✓		✓	✓	✓	✓	✓
Home series	AS07GS1ERA	✓	✓	✓	✓									✓	✓	✓	✓		✓		✓	✓	
	AS09GS1ERA	✓	✓	✓	✓									✓	✓	✓	✓		✓		✓	✓	
	AS12GS1ERA	✓	✓	✓	✓									✓	✓	✓	✓		✓		✓	✓	
	AS18GS1ERA	✓	✓	✓	✓									✓	✓	✓	✓		✓		✓	✓	
	AS24GS1ERA	✓	✓	✓	✓									✓	✓	✓	✓		✓		✓	✓	
Console series	AF09AS1ERA	✓	✓	✓	✓									✓	✓	✓		✓				✓	✓
	AF12AS1ERA	✓	✓	✓	✓									✓	✓	✓		✓				✓	✓
	AF18AS1ERA	✓	✓	✓	✓									✓	✓	✓		✓				✓	✓

✓: Standard    ✓: Optional

# Benefits



SERIES	MODEL	ENERGY SAVING									INTELLIGENT & COMFORT									HEALTH			CONVENIENT				DESIGN				
		DC motor	Auto mode	Power mode	On-Off card	Screen control	Central control	Comfortable Sleep	Quiet operation	AUTO	4-way airflow	Fresh air	Auto restart	3 minutes protection	Weekly timer	24 hours timer	Super-match	Compact design	Quick & easy installation	2 ways drain piping connection	Low ambient cooling at -10°C	Drain water pump									
Cassette type	AB09CS1ERA		✓	✓	✓	✓	✓	✓	✓	✓		✓	✓	✓	✓	✓	✓				✓	✓									
	AB12CS1ERA		✓	✓	✓	✓	✓	✓	✓	✓		✓	✓	✓	✓	✓	✓				✓	✓									
	AB18CS1ERA		✓	✓	✓	✓	✓	✓	✓	✓		✓	✓	✓	✓	✓	✓				✓	✓									
	AB24ES1ERA		✓	✓	✓	✓	✓	✓	✓	✓		✓		✓	✓	✓	✓				✓	✓									
Convertible type	AC12CS1ERA		✓	✓	✓	✓	✓	✓	✓	✓				✓	✓	✓	✓				✓										
	AC18CS1ERA		✓	✓	✓	✓	✓	✓	✓	✓				✓	✓	✓	✓				✓										
	AC24CS1ERA		✓	✓	✓	✓	✓	✓	✓	✓				✓	✓	✓	✓				✓										
Slim low ESP duct(20Pa) type	AD09SS1ERA	✓	✓	✓	✓	✓	✓	✓	✓					✓	✓	✓	✓	✓		✓	✓										
	AD12SS1ERA	✓	✓	✓	✓	✓	✓	✓	✓					✓	✓	✓	✓	✓		✓	✓										
	AD18SS1ERA	✓	✓	✓	✓	✓	✓	✓	✓					✓	✓	✓	✓	✓		✓	✓										
	AD24SS1ERA	✓	✓	✓	✓	✓	✓	✓	✓					✓	✓	✓	✓	✓		✓	✓										
Low ESP duct(25Pa) type	AD09LS1ERA		✓	✓	✓	✓	✓	✓	✓					✓	✓	✓	✓		✓	✓											
	AD12LS1ERA		✓	✓	✓	✓	✓	✓	✓					✓	✓	✓	✓		✓	✓											
	AD18LS1ERA		✓	✓	✓	✓	✓	✓	✓					✓	✓	✓	✓		✓	✓											
	AD24LS1ERA		✓	✓	✓	✓	✓	✓	✓					✓	✓	✓	✓		✓	✓											
Middle ESP duct(50Pa) type	AD12MS1ERA		✓	✓	✓	✓	✓	✓	✓			✓	✓	✓	✓	✓	✓			✓	✓										
	AD18MS1ERA		✓	✓	✓	✓	✓	✓	✓			✓	✓	✓	✓	✓	✓			✓	✓										
	AD24MS1ERA		✓	✓	✓	✓	✓	✓	✓			✓	✓	✓	✓	✓	✓			✓	✓										

✓: Standard    ✓: Optional

# Key Feature



## HIGH EFFICIENCY & COMFORTABLE

### High efficiency

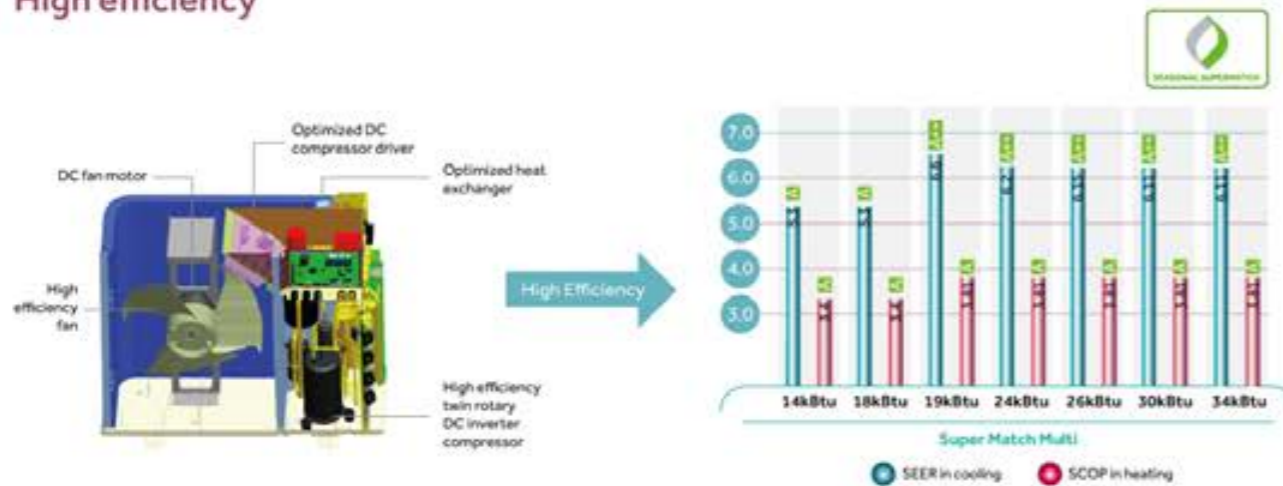

### Sleeping mode

Outdoor unit automatic switch to night silence running mode in 8 hours after the outdoor peak temperature in daytime.

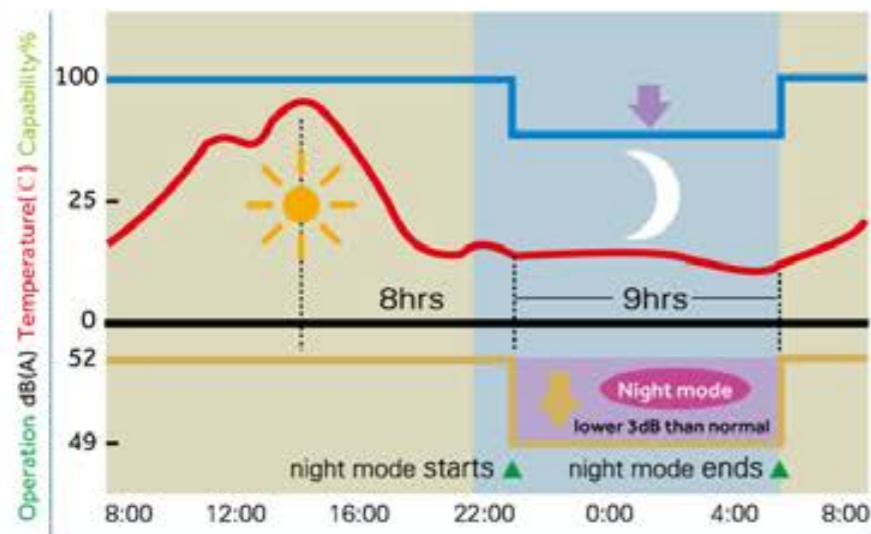

Note: this function is available in setting at site. The relationship of outdoor temperature(load) and time shown in the graph is just an example.

## HIGH RELIABILITY

### System

Multi split outdoor unit system(3U19-5U34) takes oil separator design, compressor oil come back to compressor in time, so compressor running with oil, lower compressor wear possibility, boost system reliability.



### Electrical component

Electrical box design: reserved air path (3U19-5U34) good for ventilation, working temperature of electric box can be sufficiently reduced, lower electrical component malfunction rate, boost reliability.

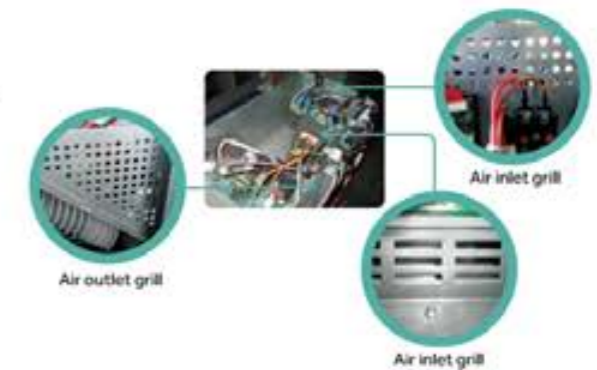

### CONTROL

High voltage communication wire guarantee the control not to be interfered by electromagnetic wave, boost control reliability.



## EASY STOCK & EASY USE, MORE USER FRIENDLY

### Easy Stock

The unified indoor units of Multi and Residential series can help our distributors and installers to reduce the inventory and save money.



### Easy control

The universal wireless controller for high wall, console, cassette, convertible, duct can be used for everyone easily.



Separate cool, heat, dry, quiet buttons easy to use!

# Key Feature



## EASY INSTALLATION, MORE USER FRIENDLY

### Easy carry



### Easy wiring

NEW WIRING SOLUTION

- > **New wiring solution:** Parallel connection, Automatic address setting and easy wiring.
- > **Note:** Red wire=power wire; Blue wire=communication wire; Black wire=pipe.



### Easy vacuum & charging

Vacuum and Charging every indoor unit just one time from general stop valve.



### Easy start up check

When start up, PCB programme can check wiring & piping correctness automatically, only need 10 minutes for every indoor unit.  
If something wrong, the outdoor unit malfunction display screen will show code. Boost the start up correctness.



### Easy start up & maintenance

#### > Service screen

In start up & maintenance, the service screen will show the failure code for easy understand to the problem.



#### > On site test software

In start up & maintenance, software can connect with outdoor unit by TD-02, read all indoor unit & outdoor unit running parameter, also with the function to show parameter curve.  
When malfunction happen, show failure code.

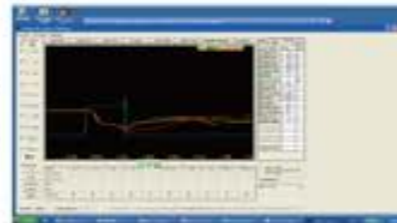

### Easy refrigerant recharge

Installer were not able to recharge refrigerant during winter seasons because cooling operation was not possible due to the low indoor temperature.

Forced cooling operation mode make cooling operation by force to make possible recharging refrigerant.



## WIDER APPLICATION

### Wider installation

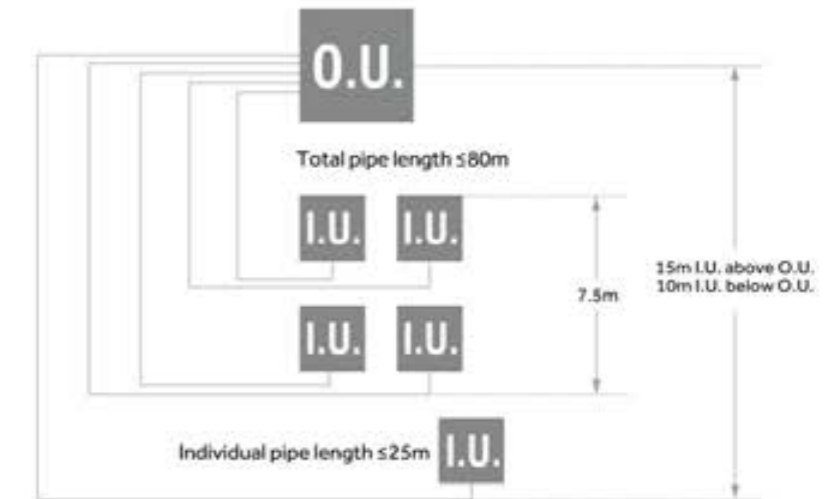

### Wider range operation

Wider range operation of outside temperature

Cooling: from -10°C to 46°C  
Heating: from -15°C to 24°C

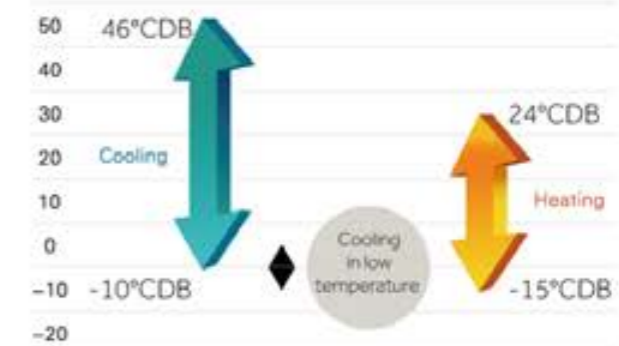

### Wider frequency application

Equipped with various DC components, the new Multi system is applicable both for 50Hz and 60Hz electricity condition.



### Wider voltage range

Working voltage: 208V-240V

The system is more tolerance in unstable voltage conditions.

# Outdoor Models



2U14CS2ERA

180° sine wave DC inverter 1:2



2U18FS2ERA

180° sine wave DC inverter 1:2



3U19FS1ERA

180° sine wave DC inverter 1:3



3U24GS1ERA

180° sine wave DC inverter 1:3



4U26HS1ERA

180° sine wave DC inverter 1:4



4U30HS1ERA

180° sine wave DC inverter 1:4



5U34HS1ERA

180° sine wave DC inverter 1:5



Model/Indoor unit			2U14CS2ERA	2U18FS2ERA	3U19FS1ERA	3U24GS1ERA	
Capacity	Cooling	Btu/h(nor)	13400	17400	18400	25200	
		kW(nor/min-max)	1.2/4.1/4.5	1.3/5.1/5.8	1.5/5.4/7	1.5/6.8/8.0	
	Heating	Btu/h(nor)	15000	19800	22100	27300	
		kW(nor/min-max)	1.5/4.4/5.0	1.9/5.8/6.6	1.8/6.5/8.1	1.8/8.0/9.0	
	Heating P design (-10°C)	kW	4.1	5.2	5.2	5.5	
Electrical parameters	Power supply	Ph/V/Hz	1/230/50	1/230/50	1/220-240/50/60	1/220-240/50/60	
	Power input	Cooling	kW(nor/min-max)	0.29/1.07/1.4	0.35/1.54/2.07	0.5/1.21/2.6	0.5/1.88/3.1
		Heating	kW(nor/min-max)	0.34/1.09/1.65	0.45/1.55/2.30	0.5/1.52/2.6	0.5/1.83/3.1
	EER/COP		/	/	4.46/4.28	4.05/4.38	
	SEER/SCOP		5.6/3.8	5.6/3.8	6.6/3.81	6.2/3.81	
	Energy class (Cooling/Heating)		A+/A	A+/A	A++/A	A++/A	
Performance	Air flow (l/M/L)	m³/h	1900	2900	2000	2500	
	Sound power level (l/M/L)	dBA	62	63	65	66	
	Sound pressure level (l/M/L)	dBA	/	53	52	53	
	External dimensions (W/D/H)	mm	780/270/540	810/288/688	810/288/688	860/308/730	
	Shipping dimensions (W/D/H)	mm	930/340/614	949/406/745	949/406/745	995/420/815	
	Net/Shipping weight	kg	58/41	45.5/46.5	51/53	55/58.5	
Installation	Compressor type		Rotary	Twin Rotary	Twin Rotary	Twin Rotary	
	Refrigerant type		R410A	R410A	R410A	R410A	
	Refrigerant liquid pipe	mm	2×6.35	2×6.35	3×6.35	3×6.35	
	Refrigerant gas pipe	mm	2×9.52	2×9.52	3×9.52	3×9.52	
	Total pipe length (Max)	m	30	30	50	50	
	Single pipe length (Max)	m	20	20	25	25	
	Max drop between I.U. & O.U.	m	15	15	15	15	
	Max drop between I.U. & I.U.	m	15	15	7.5	7.5	
	Working temp.	Cooling (Min-Max)	°C	18-46	18-46	-10-46	-10-46
		Heating (Min-Max)	°C	-15-24	-15-24	-15-24	-15-24

★ Model is under development, data is for reference.

Model/Indoor unit			4U26HS1ERA	4U30HS1ERA	5U34HS1ERA	
Capacity	Cooling	Btu/h(nor)	25900	30000	34000	
		kW(nor/min-max)	1.5/7.6/9	1.5/8.8/9.8	1.5/10/11	
	Heating	Btu/h(nor)	29300	33400	37400	
		kW(nor/min-max)	1.8/8.6/9.5	1.8/9.8/10.5	1.8/10.7/11.5	
	Heating P design (-10°C)	kW	6.0	6.2	6.5	
Electrical parameters	Power supply	Ph/V/Hz	1/220-240/50/60	1/220-240/50/60	1/220-240/50/60	
	Power input	Cooling	kW(nor/min-max)	0.55/2.07/3.5	0.55/2.40/3.8	0.55/2.94/4
		Heating	kW(nor/min-max)	0.55/2.06/3.5	0.55/2.43/3.8	0.55/2.85/4
	EER/COP		3.67/4.18	3.65/4.03	3.41/3.75	
	SEER/SCOP		6.15/3.81	6.11/3.81	6.11/3.81	
	Energy class (Cooling/Heating)		A++/A	A++/A	A++/A	
Performance	Air flow (l/M/L)	m³/h	3500	4000	4000	
	Sound power level (l/M/L)	dBA	68	69	70	
	Sound pressure level (l/M/L)	dBA	56	58	58	
	External dimensions (W/D/H)	mm	948/340/840	948/340/840	948/340/840	
	Shipping dimensions (W/D/H)	mm	1090/410/935	1090/410/935	1090/410/935	
	Net/Shipping weight	kg	74/85	76/87	77/88	
Installation	Compressor type		Twin Rotary	Twin Rotary	Twin Rotary	
	Refrigerant type		R410A	R410A	R410A	
	Refrigerant liquid pipe	mm	4×6.35	4×6.35	5×6.35	
	Refrigerant gas pipe	mm	3×9.52+1×12.7	3×9.52+1×12.7	4×9.52+1×12.7	
	Total pipe length (Max)	m	70	70	80	
	Single pipe length (Max)	m	25	25	25	
	Max drop between I.U. & O.U.	m	15	15	15	
	Max drop between I.U. & I.U.	m	7.5	7.5	7.5	
	Working temp.	Cooling (Min-Max)	°C	-10-46	-10-46	-10-46
		Heating (Min-Max)	°C	-15-24	-15-24	-15-24

★ Model is under development, data is for reference.

# AQUA SERIES



- AS07QS1ERA
- AS09QS1ERA
- AS12QS1ERA



- Nano-Aqua
- Anti-mold filter
- Evaporator self-cleaning
- Super quiet
- Extra auto mode
- Soft mode
- Power mode
- Comfortable sleep
- Left & right airflow
- 3D comfortable airflow
- Intelligent air
- Auto restart
- 3 min protection
- 24 hours timer
- Super match
- Original 3D-card IRing panel
- Compact design
- Integral stop valve cover
- Blue fin
- High quality element
- 7-color LED display
- DC motor
- High performance compressor
- 180° sine wave DC inverter

# ZIRCON SERIES

- AS07ZS2ERA
- AS09ZS2ERA
- AS12ZS2ERA
- AS18ZS2ERA

NEW



- Healthy negative ion
- Anti-mold filter
- Evaporator self-cleaning
- Super quiet
- Auto mode
- Soft mode
- Power mode
- Comfortable sleep
- Evaporator self-cleaning
- 3D sig flap
- Auto restart
- 3 min protection
- 24 hours timer
- Super match
- Easy clean design
- Disposable bag
- Base pan & drain pan separate stop
- Quick & easy installation
- 2 ways drain piping connection
- Blue fin
- High quality element
- Large "DOUBLE B" LED display
- DC motor
- High performance compressor
- 180° sine wave DC inverter

Model/Indoor unit			AS07QS1ERA	AS09QS1ERA	AS12QS1ERA
Capacity	Cooling	Btu/h(nor)	7000	9000	12000
		kW(nor/min-max)	2.0	2.6	3.5
	Heating	Btu/h(nor)	7700	9750	13200
		kW(nor/min-max)	2.2	2.86	3.85
Electrical Parameters	Heating P design(-10°C)	kW	2.0	2.6	3.5
	Power supply	Ph/V/Hz	1/230/50	1/230/50	1/230/50
Performance	Air flow (H/M/L)	m³/h	420	450	500
	Sound power level (H/M/L)	dBA	49/44/40/37	49/44/40/37	50/45/41/38
	Sound pressure level (H/M/L)	dBA	/	/	/
	External dimensions (W/D/H)	mm	860/175/285	860/175/285	860/175/285
	Shipping dimensions (W/D/H)	mm	938/265/360	938/265/360	938/265/360
Installation	Net/Shipping weight	kg	10/11.7	10/11.7	10/11.7
	Refrigerant liquid pipe	mm	6.35	6.35	6.35
	Refrigerant gas pipe	mm	9.52	9.52	9.52
	Controller	Wired(O-optional, S-standard) Infrared(O-optional, S-standard)		/	/
			YR-HD(S)	YR-HD(S)	YR-HD(S)

\* Model is under development, data is for reference.

Model/Indoor unit			AS07ZS2ERA	AS09ZS2ERA	AS12ZS2ERA	AS18ZS2ERA
Capacity	Cooling	Btu/h(nor)	7000	9000	12000	16700
		kW(nor/min-max)	2.0	2.6	3.5	4.9
	Heating	Btu/h(nor)	7700	9750	13200	17400
		kW(nor/min-max)	2.2	2.86	3.85	5.1
Electrical Parameters	Heating P design(-10°C)	kW	2.0	2.6	3.5	4.9
	Power supply	Ph/V/Hz	1/230/50	1/230/50	1/230/50	1/230/50
Performance	Air flow (H/M/L)	m³/h	600	630	700	900
	Sound power level (H/M/L)	dBA	50/45/41/38	50/45/41/38	51/45/42/39	52/49/45/42
	Sound pressure level (H/M/L)	dBA	/	/	/	/
	External dimensions (W/D/H)	mm	798/205/272	798/205/272	798/205/272	960/235/310
	Shipping dimensions (W/D/H)	mm	850/257/312	850/257/312	850/257/312	1036/313/375
Installation	Net/Shipping weight	kg	9/11	9/11	9/11	11.5/15.5
	Refrigerant liquid pipe	mm	6.35	6.35	6.35	6.35
	Refrigerant gas pipe	mm	9.52	9.52	9.52	12.7
	Controller	Wired(O-optional, S-standard) Infrared(O-optional, S-standard)		/	/	/
			YR-HD(S)	YR-HD(S)	YR-HD(S)	YR-HD(S)

\* Model is under development, data is for reference.

# Home SERIES



- AS07GS1ERA
- AS09GS1ERA
- AS12GS1ERA
- AS18GS1ERA
- AS24GS1ERA



- Anti-mold filter
- Evaporator self-cleaning
- Super quiet
- Auto mode
- Soft mode
- Power mode
- Comfortable sleep
- Intelligent air
- Auto restart
- 3 min protection
- 24 hours timer
- Blue fn.
- High quality element
- High performance compressor
- 180° sine wave DC inverter

Model/Indoor unit			AS07GS1ERA	AS09GS1ERA	AS12GS1ERA	AS18GS1ERA	AS24GS1ERA
Capacity	Cooling	Btu/h(nor)	7000	9000	12000	16700	23200
		kW(nor/min-max)	2.0	2.6	3.5	4.9	6.8
	Heating	Btu/h(nor)	7700	9750	13200	17400	24200
		kW(nor/min-max)	2.2	2.86	3.85	5.1	7.1
Electrical Parameters	Heating P design (-10°C)	kW	2.0	2.6	3.5	4.9	6.8
	Power supply	PhV/Hz	1/230/50	1/230/50	1/230/50	1/230/50	1/230/50
Performance	Air flow (l/min)	m³/h	450	450	500	850	1100
	Sound power level (l/M/L)	dBA	52/47/42/40	52/47/42/40	53/47/44/41	54/51/47/44	57/52/49/46
	Sound pressure level (l/M/L)	dBA	/	/	/	/	/
	External dimensions (W/D/H)	mm	795/187/265	795/187/265	795/187/265	938/187/265	1046/230/299
Installation	Shipping dimensions (W/D/H)	mm	871/304/360	871/304/360	871/304/360	1016/304/360	1126/344/388
	Net/Shipping weight	kg	8.8/11.3	8.8/11.3	8.8/11.3	10.5/12.5	13/16.5
	Refrigerant liquid pipe	mm	6.35	6.35	6.35	6.35	9.52
	Refrigerant gas pipe	mm	9.52	9.52	9.52	12.7	15.88
Controller	Wired (O-optional, S-standard)		/	/	/	/	/
	Infrared (O-optional, S-standard)		YR-HD(S)	YR-HD(S)	YR-HD(S)	YR-HD(S)	YR-HD(S)

★ Model is under development, data is for reference

# Console SERIES

- AF09AS1ERA
- AF12AS1ERA
- AF18AS1ERA



- Anti-mold filter
- Evaporator self-cleaning
- Super quiet
- Auto mode
- Soft mode
- Power mode
- Comfortable sleep
- Carpet airflow
- Auto restart
- 3 min protection
- 24 hours timer
- Super match
- Blue fn.
- High quality element
- "DOUBLE B" display
- High performance compressor
- 180° sine wave DC inverter

Model/Indoor unit			AF09AS1ERA	AF12AS1ERA	AF18AS1ERA
Capacity	Cooling	Btu/h(nor)	9000	12000	16700
		kW(nor/min-max)	2.6	3.5	4.9
	Heating	Btu/h(nor)	9750	13200	17400
		kW(nor/min-max)	2.86	3.85	5.1
Electrical Parameters	Heating P design (-10°C)	kW	2.6	3.5	4.9
	Power supply	PhV/Hz	1/230/50	1/230/50	1/230/50
Performance	Air flow (l/min)	m³/h	450	500	800
	Sound power level (l/M/L)	dBA	52/50/45/40	53/51/48/42	58/55/51/46
	Sound pressure level (l/M/L)	dBA	/	/	/
	External dimensions (W/D/H)	mm	720/255/640	720/255/640	720/255/640
Installation	Shipping dimensions (W/D/H)	mm	784/305/720	784/305/720	784/305/720
	Net/Shipping weight	kg	17/19.5	17/19.5	17/19.5
	Refrigerant liquid pipe	mm	6.35	6.35	6.35
	Refrigerant gas pipe	mm	9.52	9.52	12.7
Controller	Wired (O-optional, S-standard)		/	/	/
	Infrared (O-optional, S-standard)		YR-HD(S)	YR-HD(S)	YR-HD(S)

★ Model is under development, data is for reference

# SERIES CASSETTE



# SERIES CONVERTIBLE

- 🌀 AB09CS1ERA 🌀 AB18CS1ERA
- 🌀 AB12CS1ERA 🌀 AB24ES1ERA



9.12.18K



24K

### Easy maintenance

PCB inner design, installer don't need to open the closed ceiling to check, only need to open the panel to check, less trouble for maintenance.

### New particular design

The cassette external dimension is 570mm×570mm×260mm for easy installation. It is universal and harmony with standard ceiling 600mm×600mm. There is no breakage for ceiling during installation.

### Fresh air inlet

Pre-set fresh air inlet, can introduce the outside fresh air into the room, greatly improve the indoor air quality (Optional).

### Compact design

Adopt the compact design the thick of the main body is only 240mm. So even the inner space of the ceiling is narrow the unit can also be installed easily.



Model/Indoor unit			AB09CS1ERA	AB12CS1ERA	AB18CS1ERA	AB24ES1ERA
Capacity	Cooling	Btu/h(nor)	9000	12000	17000	22200
		kW(nor/min-max)	2.6	3.5	5	6.5
	Heating	Btu/h(nor)	10000	13400	17700	24300
		kW(nor/min-max)	2.9	3.7	5.2	7.1
	Heating P design(-10°C)	kW	2.5	3.4	5.1	5.5
Electrical Parameters	Power supply	Ph/V/Hz	1/230/50/60	1/230/50/60	1/230/50/60	1/230/50/60
	Air flow (H/M/L)	m <sup>3</sup> /h	620/520/450	620/520/450	680/620/500	1300/1100/870
Performance	Sound power level (H/M/L)	dBA	53/49/45	53/49/45	55/50/47	59/57/52
	Sound pressure level (H/M/L)	dBA	40/36/32	40/36/32	42/37/35	46/44/39
	External dimensions (W/D/H)	mm	570/570/260	570/570/260	570/570/260	840/840/240
Installation	Shipping dimensions (W/D/H)	mm	718/680/380	718/680/380	718/680/380	930/930/330
	Net/Shipping weight	kg	17/20	18.5/23	18.5/23	26.8/32.6
	Refrigerant liquid pipe	mm	6.35	6.35	6.35	9.52
	Refrigerant gas pipe	mm	9.52	9.52	12.7	15.88
Controller	Wired (O=optional, S=standard)		YR-E14(O)	YR-E14(O)	YR-E14(O)	YR-E14(O)
	Infrared (O=optional, S=standard)		YR-HD(S)	YR-HD(S)	YR-HD(S)	YR-HD(S)
Panel	Model		PB-700B	PB-700B	PB-700B	PB-950B
	External dimensions (W/D/H)	mm	700/700/60	700/700/60	700/700/60	950/950/60
	Shipping dimensions (W/D/H)	mm	740/750/115	740/750/115	740/750/115	985/985/115
	Net/Shipping weight	kg	2.8/4.8	2.8/4.8	2.8/4.8	4.2/6.3

★ Model is under development, data is for reference.

### Ultra-thin unit body, only thick 199mm

The convertible indoor unit adopts a double drain pan design. The unit body is very thin, only 199mm. It is beautiful, elegant and space saving.

### Wide-angle airflow

100° wide angle louvers and 70° wide angle blades design to make a precise control of the airflow. It averagely distributes the comfortable air to every corner of the room.

### Quiet running

Thanks to the low sound level centrifugal fan, the unit always works quietly so as to give more comfort to life.



12.18.24K



Model/Indoor unit			AC12CS1ERA	AC18CS1ERA	AC24CS1ERA
Capacity	Cooling	Btu/h(nor)	12000	17000	22200
		kW(nor/min-max)	3.5	5	6.3
	Heating	Btu/h(nor)	13400	18700	24300
		kW(nor/min-max)	3.9	5.5	7.1
	Heating P design(-10°C)	kW	3.4	5.1	5.5
Electrical Parameters	Power supply	Ph/V/Hz	1/230/50/60	1/230/50/60	1/230/50/60
	Air flow (H/M/L)	m <sup>3</sup> /h	650/550/450	800/720/650	850/800/720
Performance	Sound power level (H/M/L)	dBA	54/50/46	57/54/49	61/58/55
	Sound pressure level (H/M/L)	dBA	41/37/33	44/41/36	46/42/39
	External dimensions (W/D/H)	mm	990/655/199	990/655/199	990/655/199
Installation	Shipping dimensions (W/D/H)	mm	1150/750/300	1150/750/300	1150/750/300
	Net/Shipping weight	kg	26.3/32.3	28.3/34.3	28.3/34.3
	Refrigerant liquid pipe	mm	6.35	6.35	9.52
	Refrigerant gas pipe	mm	9.52	12.7	15.88
Controller	Wired (O=optional, S=standard)		YR-E14(O)	YR-E14(O)	YR-E14(O)
	Infrared (O=optional, S=standard)		YR-HD(S)	YR-HD(S)	YR-HD(S)

★ Model is under development, data is for reference.

# Slim Low ESP DUCT



# Low ESP DUCT

- 🇨🇳 AD09SS1ERA
- 🇨🇳 AD18SS1ERA
- 🇨🇳 AD12SS1ERA
- 🇨🇳 AD24SS1ERA

- 🇨🇳 AD09LS1ERA
- 🇨🇳 AD18LS1ERA
- 🇨🇳 AD12LS1ERA
- 🇨🇳 AD24LS1ERA



### 185mm super thin design and space saving

Super thin design make all the models only 185mm height, which is super slim and most advanced in the industry, this feature will bring slimmest ceiling drop.



### DC fan motor

New duct type takes DC fan motor design, this design brings super quiet and super energy efficiency.

### Optional static pressure

Two choice of optional static pressure 0 Pa and 30 Pa for the low static pressure duct make user more convenient.

### Drain pump inside design

Drain pump inside fit for difficulty design application.



Model/Indoor unit		AD09SS1ERA	AD12SS1ERA	AD18SS1ERA	AD24SS1ERA	
Capacity	Cooling	Btu/h(nor)	9000	12000	17000	23200
		kW nor/(min-max)	2.5	3.50(0.9-4.5)	5(1.8-6)	6.8(2-7.6)
	Heating	Btu/h(nor)	9900	13700	18800	24200
	kW nor/(min-max)	2.9	4.0(1-4.8)	5.5(2-6.2)	7.1(5-8.3)	
Electrical parameters	Heating P design (-10°C)	kW	2.5	3.4	5.1	5.5
	Power supply	Ph/V/Hz	1/230/50/60	1/230/50/60	1/230/50/60	1/230/50/60
Performance	Air flow (l/M/L)	m³/h	550/450/400	550	900	1100
	External static pressure	Pa	0/30	0/30	0/30	0/30
	Sound power level (l/M/L)	dB(A)	46/41/36	46/41/36	49/43/39	52/45/42
	Sound pressure level (l/M/L)	dB(A)	33/28/23	33/28/23	36/30/26	39/32/29
	External dimensions (W/D/H)	mm	850/420/185	850/420/185	1170/420/185	1170/420/185
	Shipping dimensions (W/D/H)	mm	1025/525/260	1025/525/260	1345/525/260	1345/525/260
Installation	Net/Shipping weight	kg	15/16	17/18	25/26.5	27/28.5
	Refrigerant liquid pipe	mm	6.35	6.35	6.35	9.52
	Refrigerant gas pipe	mm	9.52	9.52	12.7	15.88
	Wired(O-optional S-standard)		YR-E14(S)	YR-E14(S)	YR-E14(S)	YR-E14(S)
	Infrared(O-optional S-standard)		YR-HD(O)	YR-HD(O)	YR-HD(O)	YR-HD(O)

★ Model is under development, data is for reference.

### 220 ultra thin design and space saving

Ultra thick design make all the models have only 220mm height. It is more convenient for installation and maintenance.



### Elegant outlook fit with your style

The indoor unit placed in the ceiling only the inlet and outlet grill can be seen. The most suited grill can be used to fit with the indoor decoration.

### Optional air return design

There are two air return design for the different requestment. Let the decoration more optional.

### Optional static pressure

Two choice of optional static pressure 0 Pa and 25 Pa for the low static pressure duct make user more convenient.



Model/Indoor unit		AD09LS1ERA	AD12LS1ERA	AD18LS1ERA	AD24LS1ERA	
Capacity	Cooling	Btu/h(nor)	9000	12000	17000	23200
		kW nor/(min-max)	2.5	3.5	5	6.8
	Heating	Btu/h(nor)	9900	13700	18700	25300
	kW nor/(min-max)	2.9	4	5.5	7.1	
Electrical parameters	Heating P design (-10°C)	kW	2.5	3.4	5.1	5.5
	Power supply	Ph/V/Hz	1/230/50/60	1/230/50/60	1/230/50/60	1/230/50/60
Performance	Air flow (l/M/L)	m³/h	550/450/400	550/450/400	850/780/600	1200/1050/850
	External static pressure	Pa	0/25	0/25	0/25	0/25
	Sound power level (l/M/L)	dB(A)	50/47/44	50/47/44	54/48/45	59/55/51
	Sound pressure level (l/M/L)	dB(A)	37/34/31	37/34/31	41/35/32	46/42/38
	External dimensions (W/D/H)	mm	610/484/220	610/484/220	1090/484/220	1090/484/220
	Shipping dimensions (W/D/H)	mm	710/545/280	710/545/280	1174/545/280	1174/545/280
Installation	Net/Shipping weight	kg	14/16	14/16	23/26.5	25/28.4
	Refrigerant liquid pipe	mm	6.35	6.35	6.35	9.52
	Refrigerant gas pipe	mm	9.52	9.52	12.7	15.88
	Wired(O-optional S-standard)		YR-E14(S)	YR-E14(S)	YR-E14(S)	YR-E14(S)
	Infrared(O-optional S-standard)		YR-HD(O)	YR-HD(O)	YR-HD(O)	YR-HD(O)

★ Model is under development, data is for reference.

# Medium ESP DUCT



# Control System

- AD12MS1ERA
- AD18MS1ERA
- AD24MS1ERA



12.18K



24K



**NEW**

### Thin design and space saving

270mm thin design make the slim ceiling drop. It is convenient for installation.



270mm

### 50Pa ESP

50Pa external static pressure fit for difficult design application.

### Compact dimension

720mm(length)\* 650mm(width) fit for compact space to install the air conditioner.

### Drain pump inside design

Drain pump inside fit for difficulty design application.



Model/Indoor unit		AD12MS1ERA	AD18MS1ERA	AD24MS1ERA	
Capacity	Cooling	12000	17000	24000	
		kW (nom/min-max)	3.5(0.9-4.5)	5.1(1.8-6)	7.1(2.0-8.2)
	Heating	13700	18800	25600	
Electrical parameters		kW (nom/min-max)	4.0(1-4.8)	5.5(2-6.2)	7.5(2.5-8.5)
	Heating Power (I-10°C)	3.4	5.1	5.5	
	Power supply	1/230/50/60	1/230/50/60	1/230/50/60	
Performance	Air flow (H/M/L)	m <sup>3</sup> /h	550/450/400	880/810/630	1050/1000/900
	External static pressure	Pa	0/50	0/50	0/50
	Sound power level (H/M/L)	dBA	56/54/51	56/54/51	56/54/51
	Sound pressure level (H/M/L)	dBA	44/42/39	44/42/39	44/42/39
	External dimensions (W/D/H)	mm	720/650/270	720/650/270	950/650/270
	Shipping dimensions (W/D/H)	mm	940/860/340	940/860/340	1170/860/340
Installation	Net/Shipping weight	kg	28/30	28/30	37/39
	Refrigerant liquid pipe	mm	6.35	6.35	9.52
	Refrigerant gas pipe	mm	9.52	12.7	15.88
	Wired (optional, standard)		YR-E14(S)	YR-E14(S)	YR-E14(S)
	Infrared (optional, standard)		YR-HD(O)	YR-HD(O)	YR-HD(O)

\* Model is under development, data is for reference.

Controller & BMS	Design	Model	Functions	For what units
Touch screen central controller		YCZ-A003	*Central control, max. 15 outdoor unit systems(3U-5U) *Weekly timer *Zone control	All
Wired controller		YR-E16	*Single unit control *Group control, max. 16 units *Weekly timer *Clock *Mode: cooling, heating, auto, air flow, dehumidification *Temperature, fan speed, fan direction	Cassette Convertible Duct type
Wired controller		YR-E14	*Single unit control *Group control, max. 16 units *Clock *Timer *Mode: cooling, heating, auto, air flow, dehumidification *Temperature, fan speed, fan direction	Cassette Convertible Duct type
Infrared controller		YR-HD	*Single unit operation *Cool, heat, dry, quiet separated button *Clock *Timer *Mode: cooling, heating, auto, air flow, dehumidification	All
Wireless control receiver		RE-02	Realize infrared control for duct type	Duct

# Match Table

## 2U14CS2ERA

### COOLING

Comb.	Combinations			Rated capacity output(kW)			Total power input(kW)			Total current(A)@230V			EER(W/W)	ENERGY CLASS
	UnitA	UnitB	UnitC	UnitA	UnitB	UnitC	Min.data	Rated data	Max.data	Min.data	Rated data	Max.data		
1:2	7	—	—	1.05	2.00	2.80	0.25	0.48	0.81	1.2	2.3	3.8	5.6	A+
	9	—	—	1.05	2.40	3.10	0.25	0.58	0.90	1.2	2.7	4.2	5.6	A+
	12	—	—	1.05	3.40	3.70	0.25	0.83	1.10	1.2	3.9	5.1	5.6	A+
	7	7	—	1.20	3.80	4.10	0.29	0.97	1.28	1.4	4.5	5.9	5.4	A
	7	9	—	1.20	3.80	4.20	0.29	1.00	1.32	1.4	4.6	6.0	5.4	A
	7	12	—	1.20	3.90	4.30	0.30	1.04	1.35	1.4	4.8	6.2	5.2	A
	9	9	—	1.20	3.90	4.30	0.30	1.04	1.35	1.4	4.8	6.2	5.1	A
	9	12	—	1.20	4.00	4.40	0.30	1.07	1.40	1.4	4.9	6.3	5.1	A

### HEATING

Comb.	Combinations			Rated capacity output(kW)			Total power input(kW)			Total current(A)@230V			COP(W/W)	ENERGY CLASS
	UnitA	UnitB	UnitC	UnitA	UnitB	UnitC	Min.data	Rated data	Max.data	Min.data	Rated data	Max.data		
1:2	7	—	—	1.20	2.50	2.85	0.31	0.77	1.10	1.5	3.6	5.1	3.1	B
	9	—	—	1.20	3.10	3.35	0.31	0.94	1.26	1.5	4.4	5.9	3.1	B
	12	—	—	1.20	3.80	4.05	0.31	1.15	1.50	1.5	5.4	7.0	3.1	B
	7	7	—	1.50	4.00	4.45	0.35	1.10	1.57	1.7	5.1	7.2	3.2	B
	7	9	—	1.50	4.00	4.55	0.34	1.10	1.60	1.6	5.1	7.3	3.2	B
	7	12	—	1.50	4.20	4.65	0.34	1.10	1.60	1.6	5.1	7.3	3.4	A
	9	9	—	1.50	4.20	4.65	0.34	1.09	1.60	1.6	5.0	7.3	3.4	A
	9	12	—	1.50	4.20	4.85	0.34	1.09	1.65	1.6	5.0	7.4	3.4	A

## 2U14CS2ERA

(Only for Zircon series)

### COOLING

Comb.	Combinations			Rated capacity output(kW)			Total power input(kW)			Total current(A)@230V			EER(W/W)	ENERGY CLASS
	UnitA	UnitB	UnitC	UnitA	UnitB	UnitC	Min.data	Rated data	Max.data	Min.data	Rated data	Max.data		
1:2	7	—	—	1.05	2	2.9	0.24	0.48	0.85	1.2	2.3	4.0	6.1	A++
	9	—	—	1.05	2.5	3	0.24	0.6	0.95	1.2	2.8	4.4	6.1	A++
	12	—	—	1.05	3.5	3.8	0.24	0.88	1.14	1.2	4.2	5.3	6.1	A++
	7	7	—	1.2	3.9	4.3	0.28	0.99	1.29	1.3	4.6	5.9	5.8	A+
	7	9	—	1.2	3.9	4.3	0.29	0.99	1.32	1.4	4.6	6.0	5.8	A+
	7	12	—	1.2	4	4.4	0.29	1.02	1.36	1.4	4.7	6.2	5.6	A+
	9	9	—	1.2	4	4.4	0.29	1.02	1.36	1.4	4.7	6.2	5.6	A+
	9	12	—	1.2	4.1	4.5	0.29	1.07	1.4	1.4	4.9	6.3	5.6	A+

### HEATING

Comb.	Combinations			Rated capacity output(kW)			Total power input(kW)			Total current(A)@230V			COP(W/W)	ENERGY CLASS
	UnitA	UnitB	UnitC	UnitA	UnitB	UnitC	Min.data	Rated data	Max.data	Min.data	Rated data	Max.data		
1:2	7	—	—	1.20	2.50	3.00	0.28	0.71	1.09	1.4	3.4	5.1	3.3	B
	9	—	—	1.20	3.10	3.50	0.28	0.87	1.27	1.4	4.1	5.9	3.3	B
	12	—	—	1.20	3.80	4.20	0.28	1.04	1.52	1.4	4.9	7.1	3.3	B
	7	7	—	1.50	4.20	4.60	0.34	1.09	1.56	1.6	5.0	7.1	3.4	A
	7	9	—	1.50	4.20	4.70	0.34	1.07	1.60	1.6	4.9	7.3	3.6	A
	7	12	—	1.50	4.40	4.80	0.34	1.10	1.60	1.6	5.1	7.3	3.6	A
	9	9	—	1.50	4.40	4.80	0.34	1.09	1.60	1.6	5.0	7.3	3.8	A
	9	12	—	1.50	4.40	5.00	0.34	1.09	1.65	1.6	5.0	7.4	3.8	A

Note: Model 2U14CS2ERA can match with wall mounted type, console type and duct type only.

\* Model is under development, data is for reference.

## 2U18FS2ERA

### COOLING

Comb.	Combinations			Rated capacity output(kW)			Total power input(kW)			Total current(A)@230V			EER(W/W)	ENERGY CLASS
	UnitA	UnitB	UnitC	UnitA	UnitB	UnitC	Min.data	Rated data	Max.data	Min.data	Rated data	Max.data		
1:2	7	—	—	1.10	2.00	2.75	0.28	0.57	0.96	1.4	2.7	4.5	5.6	A+
	9	—	—	1.10	2.50	3.35	0.28	0.72	1.16	1.4	3.3	5.4	5.6	A+
	12	—	—	1.10	3.40	3.85	0.30	1.00	1.35	1.4	4.8	6.3	5.6	A+
	7	7	—	1.30	4.90	5.25	0.36	1.48	1.88	1.7	7.1	8.6	5.5	A
	7	9	—	1.30	4.90	5.25	0.36	1.48	1.88	1.7	7.1	8.6	5.3	A
	7	12	—	1.30	5.00	5.45	0.36	1.54	1.99	1.7	7.4	9.1	5.3	A
	9	9	—	1.30	5.00	5.45	0.37	1.54	1.99	1.7	7.3	9.1	5.1	A
	9	12	—	1.30	5.00	5.55	0.37	1.54	2.04	1.7	7.3	9.1	5.1	A
	12	12	—	1.30	5.00	5.65	0.37	1.54	2.08	1.7	7.3	9.3	5.1	A

### HEATING

Comb.	Combinations			Rated capacity output(kW)			Total power input(kW)			Total current(A)@230V			COP(W/W)	ENERGY CLASS
	UnitA	UnitB	UnitC	UnitA	UnitB	UnitC	Min.data	Rated data	Max.data	Min.data	Rated data	Max.data		
1:2	7	—	—	1.30	2.70	3.05	0.38	0.80	1.22	1.8	4.0	5.7	3.0	B
	9	—	—	1.30	2.95	3.55	0.38	0.86	1.40	1.8	4.3	6.5	3.0	B
	12	—	—	1.30	3.90	4.35	0.38	1.12	1.70	1.8	5.7	7.9	3.0	B
	7	7	—	1.60	5.40	6.05	0.41	1.54	2.25	1.9	7.1	10.3	3.2	B
	7	9	—	1.60	5.40	6.05	0.41	1.54	2.25	1.9	7.1	10.3	3.2	B
	7	12	—	1.70	5.60	6.25	0.42	1.55	2.25	2.0	7.4	10.3	3.4	A
	9	9	—	1.70	5.60	6.25	0.42	1.53	2.25	2.0	7.3	10.3	3.4	A
	9	12	—	1.80	5.60	6.35	0.43	1.53	2.28	2.0	7.3	10.2	3.4	A
	12	12	—	1.90	5.60	6.45	0.45	1.53	2.31	2.1	7.3	10.4	3.4	A

## 2U18FS2ERA

(Only for Zircon series)

### COOLING

Comb.	Combinations			Rated capacity output(kW)			Total power input(kW)			Total current(A)@230V			EER(W/W)	ENERGY CLASS
	UnitA	UnitB	UnitC	UnitA	UnitB	UnitC	Min.data	Rated data	Max.data	Min.data	Rated data	Max.data		
1:2	7	—	—	1.10	2.10	2.90	0.26	0.58	1.00	1.3	2.8	4.7	6.1	A++
	9	—	—	1.10	2.60	3.50	0.26	0.74	1.20	1.3	3.5	5.6	6.1	A++
	12	—	—	1.10	3.50	4.00	0.26	1.01	1.40	1.3	4.8	6.5	6.1	A++
	7	7	—	1.30	5.00	5.40	0.33	1.50	1.91	1.6	7.2	8.7	5.8	A+
	7	9	—	1.30	5.00	5.40	0.33	1.50	1.91	1.6	7.2	8.7	5.7	A+
	7	12	—	1.30	5.10	5.60	0.35	1.54	2.00	1.7	7.4	9.2	5.7	A+
	9	9	—	1.30	5.10	5.60	0.35	1.54	2.00	1.6	7.3	9.2	5.6	A+
	9	12	—	1.30	5.10	5.70	0.35	1.54	2.03	1.6	7.3	9.1	5.6	A+
	12	12	—	1.30	5.10	5.80	0.35	1.54	2.07	1.6	7.3	9.3	5.6	A+

### HEATING

Comb.	Combinations			Rated capacity output(kW)			Total power input(kW)			Total current(A)@230V			COP(W/W)	ENERGY CLASS
	UnitA	UnitB	UnitC	UnitA	UnitB	UnitC	Min.data	Rated data	Max.data	Min.data	Rated data	Max.data		
1:2	7	—	—	1.30	2.70	3.20	0.36	0.91	1.25	1.7	4.3	5.8	3.3	B
	9	—	—	1.30	2.95	3.70	0.36	0.93	1.43	1.7	4.4	6.7	3.3	B
	12	—	—	1.30	3.90	4.50	0.36	1.20	1.73	1.7	5.7	8.1	3.3	B
	7	7	—	1.60	5.60	6.20	0.41	1.60	2.25	1.9	7.2	10.3	3.4	A
	7	9	—	1.60	5.60	6.20	0.41	1.60	2.25	1.9	7.2	10.3	3.4	A
	7	12	—	1.70	5.80	6.40	0.42	1.60	2.25	2.0	7.4	10.3	3.6	A
	9	9	—	1.70	5.80	6.40	0.42	1.55	2.25	2.0	7.3	10.3	3.6	A
	9	12	—	1.80	5.80	6.50	0.43	1.55	2.28	2.0	7.3	10.2	3.8	A
	12	12	—	1.90	5.80	6.60	0.45	1.55	2.30	2.1	7.3	10.3	3.8	A

Note: Model 2U18FS2ERA can match with wall mounted type, console type and duct type only.

\* Model is under development, data is for reference.

# Match Table

## 3U19FS1ERA

### COOLING

Comb.	Combinations			Rated capacity output(kW)			Total cooling capacity(kW)			Total power input(kW)			Total current(A)@230V			EER(W/W)	ENERGY CLASS
	UnitA	UnitB	UnitC	UnitA	UnitB	UnitC	Min.data	Rated.data	Max.data	Min.data	Rated.data	Max.data	Min.data	Rated.data	Max.data		
1:1	7	—	—	2.00	—	—	1.00	2.00	2.80	0.50	0.55	1.30	2.22	2.44	5.80	3.64	A
	9	—	—	2.50	—	—	1.00	2.50	3.10	0.50	0.70	1.34	2.22	3.11	6.00	3.57	A
	12	—	—	3.50	—	—	1.00	3.50	4.10	0.50	1.00	1.50	2.22	4.44	6.70	3.50	A
	18	—	—	5.00	—	—	1.50	5.00	5.40	0.50	1.50	1.90	2.22	6.65	8.40	3.33	A
	24	—	—	5.40	—	—	1.50	5.40	6.50	0.50	1.70	2.00	2.22	7.54	8.90	3.18	B
1:2	7	7	—	2.00	2.00	—	1.00	4.00	4.40	0.50	1.30	2.60	2.22	5.77	12.00	3.08	B
	7	9	—	2.00	2.50	—	1.00	4.50	4.90	0.50	1.50	2.60	2.22	6.65	12.00	3.00	B
	7	12	—	1.96	3.44	—	1.00	5.40	5.80	0.50	1.65	2.60	2.22	7.32	12.00	3.27	A
	7	18	—	1.54	3.86	—	1.50	5.40	7.00	0.50	1.65	2.60	2.22	7.32	12.00	3.27	A
	9	9	—	2.50	2.50	—	1.00	5.00	7.00	0.50	1.55	2.60	2.22	6.88	12.00	3.23	A
	9	12	—	2.25	3.15	—	1.50	5.40	7.00	0.50	1.57	2.60	2.22	6.94	12.00	3.45	A
	9	18	—	1.80	3.60	—	1.50	5.40	7.00	0.50	1.65	2.60	2.22	7.32	12.00	3.27	A
	12	12	—	2.70	2.70	—	1.50	5.40	7.00	0.50	1.57	2.60	2.22	6.94	12.00	3.45	A
1:3	7	7	7	1.80	1.80	1.80	1.50	5.40	7.00	0.50	1.65	2.60	2.22	7.32	12.00	3.27	A
	7	7	9	1.66	1.66	2.08	1.50	5.40	7.00	0.50	1.65	2.60	2.22	7.32	12.00	3.27	A
	7	7	12	1.44	1.44	2.52	1.50	5.40	7.00	0.50	1.65	2.60	2.22	7.32	12.00	3.27	A
	7	7	18	1.20	1.20	3.00	1.50	5.40	7.00	0.50	1.65	2.60	2.22	7.32	12.00	3.27	A
	7	9	9	1.54	1.93	1.93	1.50	5.40	7.00	0.50	1.60	2.60	2.22	7.10	12.00	3.37	A
	7	9	12	1.35	1.69	2.36	1.50	5.40	7.00	0.50	1.60	2.60	2.22	7.10	12.00	3.37	A
	7	12	12	1.20	2.10	2.10	1.50	5.40	7.00	0.50	1.60	2.60	2.22	7.10	12.00	3.38	A
	9	9	9	1.80	1.80	1.80	1.50	5.40	7.00	0.50	1.41	2.60	2.22	6.25	12.00	3.84	A
	9	9	12	1.59	1.59	2.22	1.50	5.40	7.00	0.50	1.41	2.60	2.22	6.26	12.00	3.83	A
	9	12	12	1.42	1.99	1.99	1.50	5.40	7.00	0.50	1.50	2.60	2.22	6.65	12.00	3.60	A

## 3U19FS1ERA

### HEATING

Comb.	Combinations			Rated capacity output(kW)			Total cooling capacity(kW)			Total power input(kW)			Total current(A)@230V			EER(W/W)	ENERGY CLASS
	UnitA	UnitB	UnitC	UnitA	UnitB	UnitC	Min.data	Rated.data	Max.data	Min.data	Rated.data	Max.data	Min.data	Rated.data	Max.data		
1:1	7	—	—	2.30	—	—	1.00	2.30	4.00	0.47	0.60	1.50	2.09	2.66	5.80	3.83	A
	9	—	—	2.90	—	—	1.00	2.90	4.10	0.47	0.80	1.40	2.09	3.55	6.00	3.63	A
	12	—	—	3.80	—	—	1.00	3.80	4.10	0.47	1.10	1.50	2.09	4.88	6.70	3.45	B
	18	—	—	5.50	—	—	1.50	5.50	6.00	0.47	1.60	2.60	2.09	7.10	8.40	3.44	B
	24	—	—	6.50	—	—	1.50	6.50	7.00	0.47	1.80	2.60	2.09	7.99	8.90	3.61	A
1:2	7	7	—	2.30	2.30	—	1.20	4.60	5.00	0.47	1.35	2.30	2.50	5.99	10.20	3.41	B
	7	9	—	2.30	2.90	—	1.20	5.20	5.70	0.47	1.65	2.30	2.50	7.32	13.00	3.15	D
	7	12	—	2.30	3.80	—	1.20	6.10	6.50	0.47	1.65	2.30	2.50	7.32	13.00	3.70	A
	7	18	—	1.92	4.58	—	1.80	6.50	8.10	0.50	1.65	2.60	2.65	7.32	13.00	3.94	A
	9	9	—	2.90	2.90	—	1.80	5.80	8.10	0.50	1.60	2.60	2.65	7.10	13.00	3.63	A
	9	12	—	2.81	3.69	—	1.80	6.50	8.10	0.50	1.61	2.60	2.50	7.13	13.00	4.04	A
	9	18	—	2.24	4.26	—	1.80	6.50	8.10	0.50	1.65	2.60	2.50	7.32	13.00	3.94	A
	12	12	—	3.25	3.25	—	1.80	6.50	8.10	0.50	1.61	2.60	2.65	7.13	13.00	4.04	A
1:3	7	7	7	2.17	2.17	2.17	1.80	6.50	8.10	0.50	1.55	2.60	2.50	6.88	13.00	4.19	A
	7	7	9	1.99	1.99	2.51	1.80	6.50	8.10	0.50	1.60	2.60	2.65	7.10	13.00	4.06	A
	7	7	12	1.78	1.78	2.94	1.80	6.50	8.10	0.50	1.60	2.60	2.65	7.10	13.00	4.06	A
	7	7	18	1.48	1.48	3.54	1.80	6.50	8.10	0.50	1.65	2.60	2.50	7.32	13.00	3.94	A
	7	9	9	1.85	2.33	2.33	1.80	6.50	8.10	0.50	1.60	2.60	2.50	7.10	13.00	4.06	A
	7	9	12	1.66	2.09	2.74	1.80	6.50	8.10	0.50	1.55	2.60	2.50	6.88	13.00	4.19	A
	7	12	12	1.51	2.49	2.49	1.80	6.50	8.10	0.50	1.55	2.60	2.50	6.88	13.00	4.19	A
	9	9	9	2.17	2.17	2.17	1.80	6.50	8.10	0.50	1.52	2.60	2.50	6.73	13.00	4.28	A
	9	9	12	1.96	1.96	2.57	1.80	6.50	8.10	0.50	1.52	2.60	2.50	6.74	13.00	4.28	A
	9	12	12	1.80	2.35	2.35	1.80	6.50	8.10	0.50	1.55	2.60	2.50	6.88	13.00	4.19	A

# Match Table

## 3U24GS1ERA

### COOLING

Comb.	Combinations			Rated capacity(kW) (Nom. cooling)			Total cooling capacity(kW)			Total power input(kW)			Total current(A)@230V			EER(W/W)	ENERGY CLASS
	UnitA	UnitB	UnitC	UnitA	UnitB	UnitC	Min.data	Rated.data	Max.data	Min.data	Rated.data	Max.data	Min.data	Rated.data	Max.data		
1:1	7	—	—	2.0	—	—	1.00	2.00	2.80	0.50	0.55	1.30	2.22	2.44	5.8	3.64	A
	9	—	—	2.5	—	—	1.00	2.50	3.10	0.50	0.70	1.34	2.22	3.11	5.9	3.57	A
	12	—	—	3.5	—	—	1.00	3.50	4.50	0.50	1.00	1.65	2.22	4.44	7.3	3.50	A
	18	—	—	5.0	—	—	1.50	5.00	5.80	0.50	1.45	2.00	2.22	6.43	8.9	3.45	A
	24	—	—	6.5	—	—	1.50	6.50	7.30	0.50	1.90	2.60	2.22	8.43	11.5	3.42	A
1:2	7	7	—	2.00	2.00	—	1.00	4.00	5.60	0.50	1.20	2.60	2.22	5.32	11.5	3.33	A
	7	9	—	2.00	2.50	—	1.00	4.50	5.90	0.50	1.40	2.64	2.22	6.21	11.7	3.21	A
	7	12	—	2.00	3.50	—	1.00	5.50	7.30	0.50	1.65	2.95	2.22	7.32	13.0	3.33	A
	7	18	—	1.94	4.86	—	1.50	6.80	7.80	0.50	1.90	3.00	2.22	8.43	13.0	3.58	A
	9	9	—	2.50	2.50	—	1.00	5.00	6.20	0.50	1.50	2.68	2.22	6.65	13.0	3.33	A
	9	12	—	2.50	3.50	—	1.50	6.00	7.60	0.50	1.79	2.99	2.22	7.94	13.0	3.35	A
	9	18	—	2.27	4.53	—	1.50	6.80	8.00	0.50	1.87	3.00	2.22	8.30	13.0	3.64	A
	12	12	—	3.40	3.40	—	1.50	6.80	8.00	0.50	1.70	3.00	2.22	7.54	13.0	4.00	A
1:3	7	7	7	2.00	2.00	2.00	1.50	6.00	8.00	0.50	1.75	3.00	2.22	7.76	13.0	3.43	A
	7	7	9	2.00	2.00	2.50	1.50	6.50	8.00	0.50	1.87	3.00	2.22	8.30	13.0	3.48	A
	7	7	12	1.81	1.81	3.17	1.50	6.80	8.00	0.50	1.87	3.00	2.22	8.30	13.0	3.64	A
	7	7	18	1.51	1.51	3.78	1.50	6.80	8.00	0.50	1.87	3.00	2.22	8.30	13.0	3.64	A
	7	9	9	1.94	2.43	2.43	1.50	6.80	8.00	0.50	1.82	3.00	2.22	8.07	13.0	3.74	A
	7	9	12	1.70	2.13	2.98	1.50	6.80	8.00	0.50	1.82	3.00	2.22	8.07	13.0	3.74	A
	7	12	12	1.51	2.64	2.64	1.50	6.80	8.00	0.50	1.82	3.00	2.22	8.07	13.0	3.74	A
	9	9	9	2.27	2.27	2.27	1.50	6.80	8.00	0.50	1.62	3.00	2.22	7.18	13.0	4.20	A
	9	9	12	2.00	2.00	2.80	1.50	6.80	8.00	0.50	1.63	3.00	2.22	7.23	13.0	4.17	A
	9	12	12	1.79	2.51	2.51	1.50	6.80	8.00	0.50	1.63	3.00	2.22	7.23	13.0	4.17	A

★ Model is under development, data is for reference.

## 3U24GS1ERA

### HEATING

Comb.	Combinations			Rated capacity(kW) (Nom. cooling)			Total cooling capacity(kW)			Total power input(kW)			Total current(A)@230V			COP(W/W)	ENERGY CLASS
	UnitA	UnitB	UnitC	UnitA	UnitB	UnitC	Min.data	Rated.data	Max.data	Min.data	Rated.data	Max.data	Min.data	Rated.data	Max.data		
1:1	7	—	—	2.3	—	—	1.00	2.30	4.00	0.47	0.60	1.40	2.09	2.66	5.80	3.83	A
	9	—	—	2.9	—	—	1.00	2.90	4.10	0.47	0.80	1.50	2.09	3.55	6.00	3.63	A
	12	—	—	3.8	—	—	1.00	3.80	4.80	0.47	1.05	1.65	2.09	4.66	7.50	3.62	A
	18	—	—	5.5	—	—	1.50	5.50	6.20	0.47	1.50	2.00	2.09	6.65	9.50	3.67	A
	24	—	—	7.1	—	—	1.50	7.10	8.00	0.47	1.80	2.60	2.09	7.99	12.00	3.94	A
1:2	7	7	—	2.30	2.30	—	1.20	4.60	8.00	0.47	1.20	3.00	2.50	5.32	11.60	3.83	A
	7	9	—	2.30	2.90	—	1.20	5.20	8.10	0.47	1.40	2.90	2.50	6.21	11.80	3.71	A
	7	12	—	2.30	3.80	—	1.20	6.10	8.80	0.47	1.60	3.00	2.50	7.10	13.00	3.81	A
	7	18	—	2.30	5.50	—	1.80	7.80	9.00	0.50	1.90	3.00	2.65	8.43	13.00	4.11	A
	9	9	—	2.90	2.90	—	1.80	5.80	8.20	0.50	1.60	3.00	2.65	7.10	13.00	3.63	A
	9	12	—	2.90	3.80	—	1.80	6.70	8.90	0.50	1.85	3.00	2.50	8.21	13.00	3.62	A
	9	18	—	2.76	5.24	—	1.80	8.00	9.00	0.50	1.95	3.00	2.50	8.65	13.00	4.10	A
	12	12	—	3.80	3.80	—	1.80	7.60	9.00	0.50	1.90	3.00	2.65	8.43	13.00	4.00	A
1:3	7	7	7	2.30	2.30	2.30	1.80	6.90	9.00	0.50	1.85	3.00	2.50	8.21	13.00	3.73	A
	7	7	9	2.30	2.30	2.90	1.80	7.50	9.00	0.50	1.90	3.00	2.65	8.43	13.00	3.95	A
	7	7	12	2.19	2.19	3.62	1.80	8.00	9.00	0.50	1.90	3.00	2.65	8.43	13.00	4.21	A
	7	7	18	1.82	1.82	4.36	1.80	8.00	9.00	0.50	1.95	3.00	2.50	8.65	13.00	4.10	A
	7	9	9	2.27	2.86	2.86	1.80	8.00	9.00	0.50	1.90	3.00	2.50	8.43	13.00	4.21	A
	7	9	12	2.04	2.58	3.38	1.80	8.00	9.00	0.50	1.85	3.00	2.50	8.21	13.00	4.32	A
	7	12	12	1.86	3.07	3.07	1.80	8.00	9.00	0.50	1.88	3.00	2.50	8.34	13.00	4.25	A
	9	9	9	2.67	2.67	2.67	1.80	8.00	9.00	0.50	1.83	3.00	2.50	8.10	13.00	4.38	A
	9	9	12	2.42	2.42	3.17	1.80	8.00	9.00	0.50	1.85	3.00	2.50	8.21	13.00	4.32	A
	9	12	12	2.21	2.90	2.90	1.80	8.00	9.00	0.50	1.85	3.00	2.50	8.21	13.00	4.32	A

★ Model is under development, data is for reference.

# Match Table

## 4U26HS1ERA

## 4U26HS1ERA

### COOLING

Comb.	Combinations				Rated capacity(kW) (Nom. cooling)				Total cooling capacity(kW)			Total power input(kW)			Total current(A)@230V			EER(W/W)	ENERGY CLASS
	UnitA	UnitB	UnitC	UnitD	UnitA	UnitB	UnitC	UnitD	Min.data	Rated.data	Max.data	Min.data	Rated.data	Max.data	Min.data	Rated.data	Max.data		
1:1	7	—	—	—	2.00	—	—	—	1.00	2.00	2.80	0.50	0.56	1.50	2.22	2.48	5.80	3.57	A
	9	—	—	—	2.50	—	—	—	1.00	2.50	3.10	0.50	0.70	1.34	2.22	3.11	6.00	3.57	A
	12	—	—	—	3.50	—	—	—	1.00	3.50	4.10	0.50	1.00	1.50	2.22	4.44	6.70	3.50	A
	18	—	—	—	5.00	—	—	—	1.50	5.00	5.40	0.50	1.50	1.90	2.22	6.65	8.40	3.33	A
	24	—	—	—	6.50	—	—	—	1.50	6.50	7.40	0.50	2.00	3.00	2.22	8.87	13.20	3.25	A
1:2	7	18	—	—	2.00	5.00	—	—	1.00	7.00	7.40	0.50	2.25	3.50	2.15	10.87	16.80	3.11	B
	7	24	—	—	1.79	5.81	—	—	1.00	7.60	8.50	0.55	2.25	3.50	2.50	10.87	16.80	3.38	A
	9	18	—	—	2.50	5.00	—	—	1.00	7.50	7.90	0.50	2.25	3.50	2.15	10.87	16.80	3.33	A
	9	24	—	—	2.11	5.49	—	—	1.00	7.60	9.00	0.55	2.25	3.50	2.50	10.87	16.80	3.38	A
	12	12	—	—	3.50	3.50	—	—	1.00	7.00	6.80	0.50	2.19	3.50	2.15	10.57	16.80	3.20	A
	12	18	—	—	2.92	4.18	—	—	1.00	7.60	8.40	0.50	2.19	3.50	2.15	10.57	16.80	3.47	A
	12	24	—	—	2.49	4.62	—	—	1.00	7.60	9.00	0.55	2.39	3.50	2.50	11.53	16.80	3.18	B
	18	18	—	—	3.55	3.55	—	—	1.00	7.60	8.60	0.55	2.39	3.50	2.50	11.53	16.80	3.18	B
	18	24	—	—	3.09	4.01	—	—	1.00	7.60	9.00	0.55	2.40	3.50	2.50	11.58	16.80	3.17	B
1:3	7	7	9	—	2.00	2.00	2.50	—	1.20	6.50	7.10	0.55	2.00	3.50	2.50	9.66	16.80	3.25	A
	7	7	12	—	1.89	1.89	3.31	—	1.20	7.50	8.10	0.55	2.19	3.50	2.50	10.57	16.80	3.43	A
	7	7	18	—	1.58	1.58	3.94	—	1.20	7.60	8.80	0.55	2.34	3.50	2.50	11.29	16.80	3.25	A
	7	7	24	—	1.35	1.35	4.40	—	1.20	7.60	9.00	0.55	2.34	3.50	3.50	11.29	16.80	3.25	A
	7	9	9	—	2.00	2.00	2.50	—	1.20	7.00	7.10	0.55	2.14	3.50	2.50	10.32	16.80	3.28	A
	7	9	12	—	1.78	2.22	3.11	—	1.20	7.60	8.60	0.55	2.19	3.50	2.50	10.57	16.80	3.48	A
	7	9	18	—	1.49	1.87	3.74	—	1.20	7.60	8.80	0.55	2.34	3.50	2.50	11.29	16.80	3.25	A
	7	12	12	—	1.58	2.76	2.76	—	1.20	7.60	8.60	0.55	2.19	3.50	2.50	10.57	16.80	3.47	A
	7	12	18	—	1.35	2.37	3.38	—	1.20	7.60	8.80	0.55	2.34	3.50	2.50	11.29	16.80	3.25	A
	9	9	9	—	2.37	2.37	2.37	—	1.20	7.50	8.10	0.55	2.14	3.50	2.50	10.32	16.80	3.51	A
	9	9	12	—	2.09	2.09	2.92	—	1.20	7.60	8.60	0.55	2.14	3.50	2.50	10.32	16.80	3.56	A
	9	9	18	—	1.78	1.78	3.55	—	1.20	7.60	8.80	0.55	2.14	3.50	2.50	10.32	16.80	3.56	A
	9	12	12	—	1.87	2.62	2.62	—	1.20	7.60	8.60	0.55	2.14	3.50	2.50	10.32	16.80	3.56	A
12	12	12	—	2.37	2.37	2.37	—	1.20	7.60	8.50	0.55	2.14	3.50	2.50	10.32	16.80	3.56	A	
12	12	18	—	2.07	2.07	2.96	—	1.20	7.60	8.50	0.55	2.19	3.50	2.50	10.57	16.80	3.47	A	
1:4	7	7	7	7	1.78	1.78	1.78	1.78	1.50	7.60	9.00	0.55	2.14	3.50	2.85	10.32	16.80	3.56	A
	7	7	7	9	1.67	1.67	1.67	2.09	1.50	7.60	9.00	0.55	2.14	3.50	2.85	10.32	16.80	3.56	A
	7	7	7	12	1.49	1.49	1.49	2.62	1.50	7.60	9.00	0.55	2.14	3.50	2.85	10.32	16.80	3.56	A
	7	7	7	18	1.29	1.29	1.29	3.23	1.50	7.60	9.00	0.55	2.19	3.50	2.85	10.57	16.80	3.47	A
	7	7	9	9	1.58	1.58	1.97	1.97	1.50	7.60	9.00	0.55	2.14	3.50	2.85	10.32	16.80	3.56	A
	7	7	9	12	1.42	1.42	1.78	2.49	1.50	7.60	9.00	0.55	2.14	3.50	2.85	10.32	16.80	3.56	A
	7	9	9	9	1.49	1.87	1.87	1.87	1.50	7.60	9.00	0.55	2.14	3.50	2.85	10.32	16.80	3.56	A
	7	9	9	12	1.35	1.69	1.69	2.37	1.50	7.60	9.00	0.55	2.10	3.50	2.85	10.13	16.80	3.62	A
	9	9	9	9	1.78	1.78	1.78	1.78	1.50	7.60	9.00	0.55	2.10	3.50	2.85	10.13	16.80	3.62	A
	9	9	9	12	1.61	1.61	1.61	2.26	1.50	7.60	9.00	0.55	2.10	3.50	2.85	10.13	16.80	3.62	A

### HEATING

Comb.	Combinations				Rated capacity(kW) (Nom. cooling)				Total cooling capacity(kW)			Total power input(kW)			Total current(A)@230V			COP(W/W)	ENERGY CLASS
	UnitA	UnitB	UnitC	UnitD	UnitA	UnitB	UnitC	UnitD	Min.data	Rated.data	Max.data	Min.data	Rated.data	Max.data	Min.data	Rated.data	Max.data		
1:1	7	—	—	—	2.30	—	—	—	1.00	2.30	4.00	0.55	0.60	1.50	2.44	2.66	5.80	3.83	A
	9	—	—	—	2.90	—	—	—	1.00	2.90	4.10	0.55	0.80	1.40	2.44	3.55	6.00	3.63	A
	12	—	—	—	3.80	—	—	—	1.00	3.80	4.10	0.55	1.10	1.50	2.44	4.88	6.70	3.45	A
	18	—	—	—	5.50	—	—	—	1.50	5.50	6.00	0.55	1.60	2.60	2.44	7.10	8.40	3.44	A
	24	—	—	—	7.00	—	—	—	1.50	7.00	8.60	0.55	1.91	2.60	2.44	8.47	8.90	3.67	A
1:2	7	18	—	—	2.30	5.50	—	—	1.20	7.80	8.40	0.50	2.20	3.50	2.15	9.76	16.80	3.55	B
	7	24	—	—	2.13	6.47	—	—	1.20	8.60	9.50	0.55	2.31	3.50	2.50	10.24	16.80	3.72	A
	9	18	—	—	2.90	5.50	—	—	1.20	8.40	9.20	0.50	2.20	3.50	2.15	9.76	16.80	3.82	A
	9	24	—	—	2.52	6.08	—	—	1.20	8.60	9.50	0.55	2.31	3.50	2.50	10.24	16.80	3.72	A
	12	12	—	—	3.80	3.80	—	—	1.20	7.60	8.20	0.50	2.15	3.50	2.15	9.54	16.80	3.53	B
	12	18	—	—	3.51	5.09	—	—	1.20	8.60	9.50	0.50	2.30	3.50	2.15	10.20	16.80	3.74	A
	12	24	—	—	3.03	5.57	—	—	1.20	8.60	9.50	0.55	2.31	3.50	2.50	10.24	16.80	3.72	A
	18	18	—	—	4.30	4.30	—	—	1.20	8.60	9.50	0.55	2.20	3.50	2.50	9.76	16.80	3.91	A
	18	24	—	—	3.78	4.82	—	—	1.50	8.60	9.50	0.55	2.40	3.50	2.50	10.65	16.80	3.58	B
1:3	7	7	9	—	2.30	2.30	2.90	—	1.50	7.50	8.40	0.55	2.16	3.50	2.50	9.58	16.80	3.47	B
	7	7	12	—	2.30	2.30	3.80	—	1.50	8.40	9.30	0.55	2.16	3.50	2.50	9.58	16.80	3.89	A
	7	7	18	—	1.96	1.96	4.68	—	1.50	8.60	9.50	0.55	2.26	3.50	2.50	10.02	16.80	3.81	A
	7	7	24	—	1.71	1.71	5.19	—	1.80	8.60	9.50	0.55	2.31	3.50	2.50	10.24	16.80	3.72	A
	7	9	9	—	2.30	2.90	2.90	—	1.50	8.10	9.50	0.55	2.21	3.50	2.50	9.80	16.80	3.67	A
	7	9	12	—	2.20	2.77	3.63	—	1.50	8.60	9.50	0.55	2.21	3.50	2.50	9.80	16.80	3.89	A
	7	9	18	—	1.85	2.33	4.42	—	1.50	8.60	9.50	0.55	2.26	3.50	2.50	10.02	16.80	3.81	A
	7	12	12	—	2.00	3.30	3.30	—	1.50	8.60	9.50	0.55	2.21	3.50	2.50	9.80	16.80	3.89	A
	7	12	18	—	1.71	2.82	4.08	—	1.50	8.60	9.50	0.55	2.26	3.50	2.50	10.02	16.80	3.81	A
	9	9	9	—	2.87	2.87	2.87	—	1.50	8.60	9.50	0.55	2.21	3.50	2.50	9.80	16.80	3.89	A
	9	9	12	—	2.60	2.60	3.40	—	1.50	8.60	9.50	0.55	2.21	3.50	2.50	9.80	16.80	3.89	A
	9	9	18	—	2.21	2.21	4.19	—	1.50	8.60	9.50	0.55	2.26	3.50	2.50	10.02	16.80	3.81	A
	9	12	12	—	2.38	3.11	3.11	—	1.50	8.60	9.50	0.55	2.11	3.50	2.50	9.36	16.80	4.08	A
12	12	12	—	2.87	2.87	2.87	—	1.50	8.60	9.50	0.55	2.26	3.50	2.50	10.02	16.80	3.81	A	
12	12	18	—	2.49	2.49	3.61	—	1.50	8.60	9.50	0.55	2.31	3.50	2.50	1				

# Match Table

## 4U30HS1ERA

## 4U30HS1ERA

### COOLING

Comb.	Combinations				Rated capacity(kW) (Nom. cooling)				Total cooling capacity(kW)			Total power input(kW)			Total current(A)@230V			EER(W/W)	ENERGY CLASS
	UnitA	UnitB	UnitC	UnitD	UnitA	UnitB	UnitC	UnitD	Min.data	Rateddata	Max.data	Min.data	Rateddata	Max.data	Min.data	Rateddata	Max.data		
1:1	7	—	—	—	2.00	—	—	—	1.00	2.00	2.80	0.50	0.56	1.30	2.22	2.48	5.80	3.57	A
	9	—	—	—	2.50	—	—	—	1.00	2.50	3.10	0.50	0.70	1.34	2.22	3.11	6.00	3.57	A
	12	—	—	—	3.50	—	—	—	1.00	3.50	4.10	0.50	1.00	1.50	2.22	4.44	6.70	3.50	A
	18	—	—	—	5.00	—	—	—	1.50	5.00	5.40	0.50	1.50	1.90	2.22	6.65	8.40	3.33	A
24	—	—	—	6.50	—	—	—	1.50	6.50	7.40	0.50	2.00	3.00	2.22	8.87	13.20	3.25	A	
1:2	7	24	—	—	1.91	6.19	—	—	1.00	8.80	9.80	0.55	2.60	3.80	2.15	11.54	17.90	3.12	B
	9	18	—	—	2.50	5.00	—	—	1.00	7.50	9.80	0.55	2.40	3.80	2.15	10.65	17.90	3.13	B
	9	24	—	—	2.25	5.85	—	—	1.00	8.80	9.80	0.55	2.50	3.80	2.15	11.09	17.90	3.24	A
	12	18	—	—	3.16	4.94	—	—	1.00	8.80	9.80	0.55	2.40	3.80	2.15	10.65	17.90	3.37	A
	12	24	—	—	2.67	5.43	—	—	1.00	8.80	9.80	0.55	2.50	3.80	2.15	11.09	17.90	3.24	A
	18	18	—	—	4.05	4.05	—	—	1.00	8.80	9.80	0.55	2.40	3.80	2.15	10.65	17.90	3.38	A
	18	24	—	—	3.52	4.58	—	—	1.00	8.80	9.80	0.55	2.50	3.80	2.15	11.09	17.90	3.24	A
	24	24	—	—	4.05	4.05	—	—	1.00	8.80	9.80	0.55	2.60	3.80	2.15	11.54	17.90	3.12	B
1:3	7	7	18	—	1.80	1.80	4.50	—	1.50	8.80	9.80	0.55	2.40	3.80	2.50	10.65	17.90	3.38	A
	7	7	24	—	1.54	1.54	5.01	—	1.50	8.80	9.80	0.55	2.50	3.80	2.50	11.09	17.90	3.24	A
	7	9	12	—	2.00	2.50	3.50	—	1.50	8.00	9.80	0.55	2.30	3.80	2.50	10.20	17.90	3.48	A
	7	9	18	—	1.71	2.13	4.26	—	1.50	8.80	9.80	0.55	2.40	3.80	2.50	10.65	17.90	3.37	A
	7	9	24	—	1.47	1.84	4.79	—	1.50	8.80	9.80	0.55	2.50	3.80	2.50	11.09	17.90	3.24	A
	7	12	12	—	1.80	3.15	3.15	—	1.50	8.80	9.80	0.55	2.40	3.80	2.50	10.65	17.90	3.38	A
	7	12	18	—	1.54	2.70	3.86	—	1.50	8.80	9.80	0.55	2.40	3.80	2.50	10.65	17.90	3.37	A
	7	12	24	—	1.35	2.36	4.39	—	1.50	8.80	9.80	0.55	2.50	3.80	2.50	11.09	17.90	3.24	A
	9	9	9	—	2.50	2.50	2.50	—	1.50	7.50	9.80	0.55	2.30	3.80	2.50	10.20	17.90	3.26	A
	9	9	12	—	2.38	2.38	3.34	—	1.50	8.80	9.80	0.55	2.35	3.80	2.50	10.43	17.90	3.44	A
	9	9	18	—	2.03	2.03	4.05	—	1.50	8.80	9.80	0.55	2.40	3.80	2.50	10.65	17.90	3.38	A
	9	9	24	—	1.76	1.76	4.58	—	1.50	8.80	9.80	0.55	2.50	3.80	2.50	11.09	17.90	3.24	A
	9	12	12	—	2.15	2.98	2.98	—	1.50	8.80	9.80	0.55	2.40	3.80	2.50	10.65	17.90	3.37	A
	9	12	18	—	1.84	2.58	3.68	—	1.50	8.80	9.80	0.55	2.40	3.80	2.50	10.65	17.90	3.37	A
	9	12	24	—	1.62	2.27	4.21	—	1.50	8.80	9.80	0.55	2.50	3.80	2.50	11.09	17.90	3.24	A
	12	12	12	—	2.70	2.70	2.70	—	1.50	8.80	9.80	0.55	2.40	3.80	2.50	10.65	17.90	3.38	A
	12	12	18	—	2.36	2.36	3.38	—	1.50	8.80	9.80	0.55	2.40	3.80	2.50	10.65	17.90	3.37	A
	12	12	24	—	2.10	2.10	3.90	—	1.50	8.80	9.80	0.55	2.45	3.80	2.50	10.87	17.90	3.31	A
	12	18	18	—	2.10	3.00	3.00	—	1.50	8.80	9.80	0.55	2.50	3.80	2.50	11.09	17.90	3.24	A
	1:4	7	7	7	7	2.00	2.00	2.00	2.00	1.50	8.00	9.80	0.55	2.25	3.80	2.85	9.98	17.90	3.56
7		7	7	9	1.91	1.91	1.91	2.38	1.50	8.80	9.80	0.55	2.25	3.80	2.85	9.98	17.90	3.60	A
7		7	7	12	1.71	1.71	1.71	2.98	1.50	8.80	9.80	0.55	2.25	3.80	2.85	9.98	17.90	3.60	A
7		7	7	18	1.47	1.47	1.47	3.68	1.50	8.80	9.80	0.55	2.40	3.80	2.85	10.65	17.90	3.37	A
7		7	7	24	1.30	1.30	1.30	4.21	1.50	8.80	9.80	0.55	2.50	3.80	2.85	11.09	17.90	3.24	A
7		7	9	9	1.80	1.80	2.25	2.25	1.50	8.80	9.80	0.55	2.25	3.80	2.85	9.98	17.90	3.60	A
7		7	9	12	1.62	1.62	2.03	2.84	1.50	8.80	9.80	0.55	2.25	3.80	2.85	9.98	17.90	3.60	A
7		7	9	18	1.41	1.41	1.76	3.52	1.50	8.80	9.80	0.55	2.40	3.80	2.85	10.65	17.90	3.37	A
7		7	9	24	1.25	1.25	1.56	4.05	1.50	8.80	9.80	0.55	2.45	3.80	2.85	10.87	17.90	3.31	A
7		7	12	12	1.47	1.47	2.58	2.58	1.50	8.80	9.80	0.55	2.25	3.80	2.85	9.98	17.90	3.60	A
7		7	12	18	1.30	1.30	2.27	3.24	1.50	8.80	9.80	0.55	2.40	3.80	2.85	10.65	17.90	3.38	A
7		9	9	9	1.71	2.13	2.13	2.13	1.50	8.80	9.80	0.55	2.25	3.80	2.85	9.98	17.90	3.60	A
7		9	9	12	1.54	1.93	1.93	2.70	1.50	8.80	9.80	0.55	2.28	3.80	2.85	10.12	17.90	3.55	A
7		9	9	18	1.35	1.69	1.69	3.38	1.50	8.80	9.80	0.55	2.40	3.80	2.85	10.65	17.90	3.37	A
7		9	12	12	1.41	1.76	2.47	2.47	1.50	8.80	9.80	0.55	2.30	3.80	2.85	10.20	17.90	3.52	A
7		12	12	12	1.30	2.27	2.27	2.27	1.50	8.80	9.80	0.55	2.30	3.80	2.85	10.20	17.90	3.52	A
9		9	9	9	2.03	2.03	2.03	2.03	1.50	8.80	9.80	0.55	2.22	3.80	2.85	9.85	17.90	3.65	A
9		9	9	12	1.84	1.84	1.84	2.58	1.50	8.80	9.80	0.55	2.25	3.80	2.85	9.98	17.90	3.60	A
9		9	12	12	1.69	1.69	2.36	2.36	1.50	8.80	9.80	0.55	2.25	3.80	2.85	9.98	17.90	3.60	A
9		9	12	18	1.50	1.50	2.10	3.00	1.50	8.80	9.80	0.55	2.30	3.80	2.85	10.20	17.90	3.52	A
9	12	12	12	1.56	2.18	2.18	2.18	1.50	8.80	9.80	0.55	2.35	3.80	2.85	10.43	17.90	3.45	A	
12	12	12	12	2.03	2.03	2.03	2.03	1.50	8.80	9.80	0.55	2.35	3.80	2.85	10.43	17.90	3.45	A	

### HEATING

Comb.	Combinations				Rated capacity(kW) (Nom. cooling)				Total heating capacity(kW)			Total power input(kW)			Total current(A)@230V			COP(W/W)	ENERGY CLASS
	UnitA	UnitB	UnitC	UnitD	UnitA	UnitB	UnitC	UnitD	Min.data	Rateddata	Max.data	Min.data	Rateddata	Max.data	Min.data	Rateddata	Max.data		
1:1	7	—	—	—	2.30	—	—	—	1.00	2.30	4.00	0.55	0.60	1.50	2.44	2.66	5.80	5.83	A
	9	—	—	—	2.90	—	—	—	1.00	2.90	4.10	0.55	0.80	1.40	2.44	3.55	6.00	3.63	A
	12	—	—	—	3.80	—	—	—	1.00	3.80	4.10	0.55	1.10	1.50	2.44	4.88	6.70	3.45	B
	18	—	—	—	5.50	—	—	—	1.50	5.50	6.00	0.55	1.60	2.60	2.44	7.10	8.40	3.44	B
24	—	—	—	7.00	—	—	—	1.50	7.00	8.60	0.55	1.80	2.60	2.44	7.99	8.90	3.89	A	
1:2	7	24	—	—	2.30	7.00	—	—	1.20	9.30	10.50	0.50	2.60	3.80	2.15	11.54	15.00	3.58	B
	9	18	—	—	2.90	5.50	—	—	1.20	8.40	10.50	0.50	2.60	3.80	2.15	11.54	15.00	3.23	C
	9	24	—	—	2.67	6.93	—	—	1.20	9.80	10.50	0.50	2.70	3.80	2.15	11.98	15.00	3.63	A
	12	18	—	—	3.80	5.50	—	—	1.20	9.30	10.50	0.50	2.60	3.80	2.15	11.54	15.00	3.58	B
	12	24	—	—	3.45	6.35	—	—	1.20	9.80	10.50	0.50	2.70	3.80	2.15	11.98	15.00	3.63	A
	18	18	—	—	4.90	4.90	—	—	1.20	9.80	10.50	0.50	2.60	3.80	2.15	11.54	15.00	3.77	A
	18	24	—	—	4.31	5.49	—	—	1.20	9.80	10.50	0.50	2.70	3.80	2.15	11.98	15.00	3.63	A
	24	24	—	—	4.90	4.90	—	—	1.20	9.80	10.50	0.50	2.75	3.80	2.44	12.20	15.00	3.56	B
1:3	7	7	18	—	2.23	2.23	5.34	—	1.20	9.80	10.50	0.55	2.60	3.80	2.50	11.54	15.00	3.77	A
	7	7	24	—	1.94	1.94	5.91	—	1.50	9.80	10.50	0.55	2.70	3.80	2.50	11.98	15.00	3.63	A
	7	9	12	—	2.30	2.90	3.80	—	1.50	9.00	10.50	0.55	2.60	3.80	2.50	11.54	15.00	3.46	B
	7	9	18	—	2.11	2.66	5.04	—	1.50	9.80	10.50	0.55	2.60	3.80	2.50	11.54	15.00	3.77	A
	7	9	24	—	1.														

# Match Table

## 5U34HS1ERA

## 5U34HS1ERA

### COOLING

Comb.	Combinations				Rated capacity(kW) (Nom. cooling)				Total cooling capacity(kW)			Total power input(kW)			Total current(A)@230V			EER(W/W)	ENERGY CLASS			
	UnitA	UnitB	UnitC	UnitD	UnitE	UnitA	UnitB	UnitC	UnitD	UnitE	Min.data	Rated.data	Max.data	Min.data	Rated.data	Max.data	Min.data			Rated.data	Max.data	Rated.capacity
1:1	7	—	—	—	—	2.00	—	—	—	—	1.00	2.00	2.80	0.50	0.65	1.30	2.20	2.88	5.80	3.08	B	
	9	—	—	—	—	2.50	—	—	—	—	1.00	2.50	3.10	0.50	0.80	1.34	2.20	3.55	6.00	3.13	B	
	12	—	—	—	—	3.50	—	—	—	—	1.00	3.50	4.10	0.50	1.04	1.50	2.20	4.61	6.70	3.37	A	
	18	—	—	—	—	5.00	—	—	—	—	1.50	5.00	5.40	0.50	1.50	1.90	2.20	6.65	8.40	3.33	A	
	24	—	—	—	—	6.50	—	—	—	—	1.50	6.50	7.40	0.50	2.00	3.00	2.20	8.87	13.20	3.25	A	
1:2	7	18	—	—	—	2.00	5.00	—	—	—	1.00	7.00	7.50	0.50	2.30	4.00	2.15	10.20	19.00	3.04	B	
	7	24	—	—	—	2.00	6.50	—	—	—	1.00	8.50	9.00	0.50	2.80	4.00	2.15	12.42	19.00	3.04	B	
	9	18	—	—	—	2.50	5.00	—	—	—	1.00	7.50	8.00	0.50	2.40	4.00	2.15	10.65	19.00	3.13	B	
	9	24	—	—	—	2.50	6.50	—	—	—	1.00	9.00	9.50	0.50	2.70	4.00	2.15	11.98	19.00	3.33	A	
	12	18	—	—	—	3.50	5.00	—	—	—	1.00	8.50	9.00	0.50	2.70	4.00	2.15	11.98	19.00	3.15	B	
	12	24	—	—	—	3.50	6.50	—	—	—	1.00	10.00	10.50	0.50	3.10	4.00	2.15	13.75	19.00	3.23	A	
	18	18	—	—	—	5.00	5.00	—	—	—	1.00	10.00	10.50	0.50	3.10	4.00	2.15	13.75	19.00	3.23	A	
	18	24	—	—	—	4.55	5.65	—	—	—	1.00	10.00	10.50	0.50	3.10	4.00	2.15	13.75	19.00	3.22	A	
	24	24	—	—	—	5.00	5.00	—	—	—	1.00	10.00	10.50	0.50	3.20	4.00	2.15	14.20	19.00	3.13	B	
1:3	7	7	12	—	—	2.00	2.00	3.50	—	—	1.50	7.50	8.10	0.55	2.74	4.00	2.50	12.16	19.00	2.74	D	
	7	7	18	—	—	2.00	2.00	5.00	—	—	1.50	9.00	9.80	0.55	2.74	4.00	2.50	12.16	19.00	3.28	A	
	7	7	24	—	—	1.90	1.90	6.19	—	—	1.50	10.00	10.50	0.55	3.04	4.00	2.50	13.49	19.00	3.29	A	
	7	9	9	—	—	2.00	2.50	2.50	—	—	1.50	7.00	7.80	0.55	2.74	4.00	2.50	12.16	19.00	2.55	E	
	7	9	12	—	—	2.00	2.50	3.50	—	—	1.50	8.00	8.60	0.55	2.74	4.00	2.50	12.16	19.00	2.92	C	
	7	9	18	—	—	2.00	2.50	5.00	—	—	1.50	9.50	10.20	0.55	2.90	4.00	2.50	12.87	19.00	3.28	A	
	7	9	24	—	—	1.82	2.27	5.91	—	—	1.50	10.00	10.50	0.55	3.04	4.00	2.50	13.49	19.00	3.29	A	
	7	12	12	—	—	2.00	3.50	3.50	—	—	1.50	9.00	9.60	0.55	3.04	4.00	2.50	13.49	19.00	2.96	C	
	7	12	18	—	—	1.90	3.33	4.76	—	—	1.50	10.00	10.50	0.55	3.04	4.00	2.50	13.49	19.00	3.29	A	
	7	12	24	—	—	1.67	2.92	5.42	—	—	1.50	10.00	10.50	0.55	3.04	4.00	2.50	13.49	19.00	3.29	A	
	9	9	9	—	—	2.50	2.50	2.50	—	—	1.50	7.50	8.10	0.55	3.04	4.00	2.50	13.49	19.00	2.47	E	
	9	9	12	—	—	2.50	2.50	3.50	—	—	1.50	8.50	9.10	0.55	3.04	4.00	2.50	13.49	19.00	2.80	D	
	9	9	18	—	—	2.50	2.50	5.00	—	—	1.50	10.00	10.50	0.55	3.04	4.00	2.50	13.49	19.00	3.29	A	
	9	9	24	—	—	2.17	2.17	5.65	—	—	1.50	10.00	10.50	0.55	3.04	4.00	2.50	13.49	19.00	3.29	A	
	9	12	12	—	—	2.50	5.50	3.50	—	—	1.50	9.50	10.20	0.55	3.04	4.00	2.50	13.49	19.00	3.13	B	
	9	12	18	—	—	2.27	3.18	4.55	—	—	1.50	10.00	10.50	0.55	3.04	4.00	2.50	13.49	19.00	3.29	A	
	9	12	24	—	—	2.00	2.80	5.20	—	—	1.50	10.00	10.50	0.55	3.04	4.00	2.50	13.49	19.00	3.29	A	
	12	12	12	—	—	3.33	3.33	3.33	—	—	1.50	10.00	10.50	0.55	3.04	4.00	2.50	13.49	19.00	3.29	A	
	12	12	18	—	—	2.92	2.92	4.17	—	—	1.50	10.00	10.50	0.55	2.99	4.00	2.50	13.27	19.00	3.34	A	
	12	12	24	—	—	2.59	2.59	4.81	—	—	1.50	10.00	11.00	0.55	3.27	4.00	2.50	14.51	19.00	3.06	B	
	12	18	18	—	—	2.59	3.70	3.70	—	—	1.50	10.00	11.00	0.55	3.27	4.00	2.50	14.51	19.00	3.06	B	
	18	18	18	—	—	3.33	3.33	3.33	—	—	1.80	10.00	11.00	0.55	3.32	4.00	2.50	14.73	19.00	3.01	B	
	1:4	7	7	7	7	—	2.00	2.00	2.00	2.00	—	1.80	8.00	8.80	0.55	2.89	4.00	2.50	12.82	19.00	2.77	D
		7	7	7	9	—	2.00	2.00	2.00	2.50	—	1.80	8.50	9.30	0.55	2.89	4.00	2.50	12.82	19.00	2.94	C
7		7	7	12	—	2.00	2.00	2.00	3.50	—	1.80	9.50	10.30	0.55	2.96	4.00	2.50	13.13	19.00	3.21	A	
7		7	7	18	—	1.82	1.82	1.82	4.55	—	1.80	10.00	11.00	0.55	2.99	4.00	2.50	13.27	19.00	3.34	A	
7		7	7	24	—	1.60	1.60	1.60	5.20	—	1.80	10.00	11.00	0.55	2.99	4.00	2.50	13.27	19.00	3.34	A	
7		7	9	9	—	2.00	2.00	2.50	2.50	—	1.80	9.00	9.80	0.55	2.96	4.00	2.50	13.13	19.00	3.04	B	
7		7	9	12	—	2.00	2.00	2.50	3.50	—	1.80	10.00	10.50	0.55	2.96	4.00	2.50	13.13	19.00	3.38	A	
7		7	9	18	—	1.74	1.74	2.17	4.35	—	1.80	10.00	11.00	0.55	2.99	4.00	2.50	13.27	19.00	3.34	A	
7		7	9	24	—	1.54	1.54	1.92	5.00	—	1.80	10.00	11.00	0.55	2.99	4.00	2.50	13.27	19.00	3.34	A	
7		7	12	12	—	1.82	1.82	3.18	3.18	—	1.80	10.00	10.80	0.55	2.96	4.00	2.50	13.13	19.00	3.38	A	
7		7	12	18	—	1.60	1.60	2.80	4.00	—	1.80	10.00	11.00	0.55	2.99	4.00	2.50	13.27	19.00	3.34	A	
7		9	9	9	—	2.00	2.50	2.50	2.50	—	1.80	9.50	10.30	0.55	2.96	4.00	2.50	13.13	19.00	3.21	A	
7		9	9	12	—	1.90	2.38	2.38	3.33	—	1.80	10.00	10.80	0.55	2.99	4.00	2.50	13.27	19.00	3.34	A	
7		9	9	18	—	1.67	2.08	2.08	4.17	—	1.80	10.00	11.00	0.55	2.99	4.00	2.50	13.27	19.00	3.34	A	
7		9	12	12	—	1.74	2.17	3.04	3.04	—	1.80	10.00	10.80	0.55	2.96	4.00	2.50	13.13	19.00	3.38	A	
7		12	12	12	—	1.60	2.80	2.80	2.80	—	1.80	10.00	11.00	0.55	2.96	4.00	2.50	13.13	19.00	3.38	A	
9		9	9	9	—	2.50	2.50	2.50	2.50	—	1.80	10.00	11.00	0.55	3.01	4.00	2.50	13.35	19.00	3.32	A	
9		9	9	12	—	2.27	2.27	2.27	3.18	—	1.80	10.00	11.00	0.55	2.96	4.00	2.50	13.13	19.00	3.38	A	
9		9	9	18	—	2.00	2.00	2.00	4.00	—	1.80	10.00	11.00	0.55	2.94	4.00	2.50	13.04	19.00	3.40	A	
9		9	12	12	—	2.08	2.08	2.92	2.92	—	1.80	10.00	11.00	0.55	2.96	4.00	2.50	13.13	19.00	3.38	A	
9		12	12	12	—	1.92	2.69	2.69	2.69	—	1.80	10.00	11.00	0.55	2.96	4.00	2.50	13.13	19.00	3.38	A	
12		12	12	12	—	2.50	2.50	2.50	2.50	—	1.80	10.00	11.00	0.55	2.97	4.00	2.50	13.18	19.00	3.37	A	
1:5		7	7	7	7	7	2.00	2.00	2.00	2.00	2.00	2.00	10.00	11.00	0.55	3.01	4.00	2.50	13.35	19.00	3.32	A
		7	7	7	7	9	1.90	1.90	1.90	2.38	2.00	2.00	10.00	11.00	0.							



<b>Models Line-up</b>	<b>069</b>
<b>Benefits</b>	<b>071</b>
<b>Key Feature</b>	<b>073</b>
Cassette	<b>075</b>
Convertible	<b>081</b>
Low ESP Duct	<b>090</b>
Slim Low ESP Duct	<b>091</b>
Medium ESP Duct	<b>092</b>
High ESP Duct	<b>094</b>
Cabinet	<b>095</b>
<b>Control System</b>	<b>098</b>

# LIGHT COMMERCIAL DC

# Models Line-up

All Models Super Match

	SEASONAL SUPERMATCH			SEASONAL SUPERMATCH		SEASONAL SUPERMATCH		SEASONAL SUPERMATCH	
Btu/h	12000	18000	24000	28000	36000	48000	60000		
kW	3.6	5.2	7.0	8.2	10.5	12.5	16		
Universal outdoor unit	1U12BS2ERA 	1U18FS2ERA 	1U24GS1ERA 	1U28HS1ERA 	1U36HS1ERA 	1U48LS1ERA 1U48LS1ERB 	1U60S1ERA 1U60S1ERB 		
Cassette type	AB12CS1ERA 	AB18CS1ERA 	AB24ES1ERA 	AB28ES1ERA 	AB36ES1ERA 	AB48ES1ERA 	AB60CS1ERA 		
Convertible type	AC12CS1ERA 	AC18CS1ERA 	AC24CS1ERA 	AC28ES1ERA 	AC36ES1ERA 	AC48FS1ERA 	AC60FS1ERA 		
Low ESP duct type 25Pa	AD12LS1ERA 	AD18LS1ERA 	AD24LS1ERA 						
Slim low ESP duct type 30Pa	AD12SS1ERA 	AD18SS1ERA 	AD24SS1ERA 						
Medium ESP duct type 50/100Pa	AD12SM1ERA 	AD18MS1ERA 	AD24MS1ERA 	AD28NS1ERA 	AD36NS1ERA 	AD48NS1ERA 			
High ESP duct type 150Pa						AD48HS1ERA 	AD60HS1ERA 		
Cabinet type						AP48DS1ERA AP48KS1ERA 	AP60KS1ERA 		

\* Design, specifications and model pictures are subject to change without prior notice for product improvement.

# Benefits



SERIES	MODEL	ENERGY SAVING			INTELLIGENT & COMFORT								HEALTH			CONVENIENT				DESIGN								
		DC motor	High performance compressor	180° sine wave DC inverter	Auto mode	Power mode	On-Off card	Group control	Central control	Comfortable sleep	Left & Right airflow	3D comfortable airflow	Quiet operation	Auto-swing	4-way airflow	Fresh air	Auto restart	3 minutes protection	Weekly timer	24 hours timer	Super match	Compact design	Easy clean design	2 ways drain piping connection	Drain water pump	LED display	LCD display	
Cassette type	AB12CS1ERA	✓	✓	✓	✓	✓	✓	✓	✓	✓		✓	✓	✓	✓	✓	✓	✓	✓	✓	✓			✓				
	AB18CS1ERA	✓	✓	✓	✓	✓	✓	✓	✓	✓		✓	✓	✓	✓	✓	✓	✓	✓	✓	✓	✓			✓			
	AB24ES1ERA	✓	✓	✓	✓	✓	✓	✓	✓	✓		✓	✓	✓		✓	✓	✓	✓	✓	✓	✓			✓			
	AB28ES1ERA	✓	✓	✓	✓	✓	✓	✓	✓	✓		✓	✓	✓		✓	✓	✓	✓	✓	✓	✓	✓			✓		
	AB36ES1ERA	✓	✓	✓	✓	✓	✓	✓	✓	✓		✓	✓	✓	✓	✓	✓	✓	✓	✓	✓	✓	✓			✓		
	AB48ES1ERA	✓	✓	✓	✓	✓	✓	✓	✓	✓		✓	✓	✓	✓	✓	✓	✓	✓	✓	✓	✓	✓			✓		
Convertible type	AB60CS1ERA	✓	✓	✓	✓	✓	✓	✓	✓		✓	✓	✓	✓	✓	✓	✓	✓	✓	✓	✓	✓			✓			
	AC12CS1ERA	✓	✓	✓	✓	✓	✓	✓	✓		✓	✓			✓	✓	✓	✓	✓	✓	✓	✓						
	AC18CS1ERA	✓	✓	✓	✓	✓	✓	✓	✓		✓	✓			✓	✓	✓	✓	✓	✓	✓	✓						
	AC24CS1ERA	✓	✓	✓	✓	✓	✓	✓	✓		✓	✓			✓	✓	✓	✓	✓	✓	✓	✓						
	AC28ES1ERA	✓	✓	✓	✓	✓	✓	✓	✓	✓	✓	✓			✓	✓	✓	✓	✓	✓	✓	✓						
	AC36ES1ERA	✓	✓	✓	✓	✓	✓	✓	✓	✓	✓	✓	✓			✓	✓	✓	✓	✓	✓	✓						
Slim low ESP duct(20Pa) type	AC48FS1ERA	✓	✓	✓	✓	✓	✓	✓	✓	✓	✓	✓			✓	✓	✓	✓	✓	✓	✓							
	AC60FS1ERA	✓	✓	✓	✓	✓	✓	✓	✓	✓	✓	✓	✓			✓	✓	✓	✓	✓	✓							
	AD12SS1ERA	✓	✓	✓	✓	✓	✓	✓	✓	✓		✓				✓	✓	✓	✓	✓	✓	✓					✓	
Low ESP duct(25Pa) type	AD18SS1ERA	✓	✓	✓	✓	✓	✓	✓	✓		✓				✓	✓	✓	✓	✓	✓	✓					✓		
	AD24SS1ERA	✓	✓	✓	✓	✓	✓	✓	✓		✓				✓	✓	✓	✓	✓	✓	✓					✓		
	AD12LS1ERA		✓	✓	✓	✓	✓	✓	✓		✓					✓	✓	✓	✓	✓	✓		✓					
Medium ESP duct(50Pa) type	AD18LS1ERA		✓	✓	✓	✓	✓	✓		✓					✓	✓	✓	✓	✓	✓		✓						
	AD24LS1ERA		✓	✓	✓	✓	✓	✓		✓					✓	✓	✓	✓	✓	✓		✓						
	AD12MS1ERA		✓	✓	✓	✓	✓	✓	✓		✓			✓	✓	✓	✓	✓	✓	✓	✓					✓		
	AD18MS1ERA		✓	✓	✓	✓	✓	✓	✓		✓			✓	✓	✓	✓	✓	✓	✓	✓					✓		
	AD24MS1ERA		✓	✓	✓	✓	✓	✓	✓		✓			✓	✓	✓	✓	✓	✓	✓	✓					✓		
High ESP duct type	AD28NS1ERA		✓	✓	✓	✓	✓	✓		✓					✓	✓	✓	✓	✓	✓								
	AD36NS1ERA		✓	✓	✓	✓	✓	✓		✓					✓	✓	✓	✓	✓	✓								
	AD48NS1ERA		✓	✓	✓	✓	✓	✓		✓					✓	✓	✓	✓	✓	✓								
Cabinet type	AD48HS1ERA		✓	✓	✓	✓	✓	✓		✓					✓	✓	✓	✓	✓	✓								
	AD60HS1ERA		✓	✓	✓	✓	✓	✓		✓					✓	✓	✓	✓	✓	✓								
	AP48DS1ERA		✓	✓	✓	✓	✓	✓	✓	✓	✓	✓				✓	✓	✓	✓	✓	✓		✓			✓		
	AP48KS1ERA		✓	✓	✓	✓	✓	✓	✓	✓	✓	✓				✓	✓	✓	✓	✓						✓		
	AP60KS1ERA		✓	✓	✓	✓	✓	✓	✓	✓	✓	✓				✓	✓	✓	✓	✓						✓		

✓: Standard    ✓: Optional

# Key Feature



## ENERGY EFFICIENCY

In compliance with the 2013 EU Regulation No 206/2012 for SEER and sound power level requirement, even reaching A/A with 5.1/3.4.



## DC INVERTER TECHNOLOGY

### Powerful startup

Haler DC inverter system can startup and running at maximum frequency very quickly in order to reach the set temperature in the shortest time, which brings you great comfort experience.

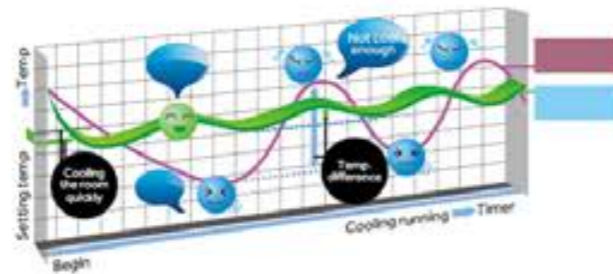

### Minimum running

Haler DC inverter system will reduce the frequency and running smoothly according to the real load request after reach the set temperature. The system running cost reduced drastically which brings your real benefit of money saving.

## INSTALLATION FRIENDLY

### Easy start up & maintenance



In start up & maintenance, software can connect with outdoor unit by TD-01, read all indoor unit & outdoor unit running parameter, also with the function to show parameter curve.

When malfunction happen, show failure code.

## STOCK FRIENDLY

### Easy stock

For 48k combination, we have totally 6 indoor units, which are one cassette type, one convertible type, one middle ESP duct type, one high ESP duct type, two cabinet types. 48k indoor units can meet all installation applications.

The 6 indoor units can match with 2 inverter outdoor units (12.5kW 1phase/3 phase), also can match with 2 fixed-speed outdoor units (12.5/14kW both 3 phase) in single split way.

This design is a huge Super match which can reduce your model stock quantity drastically.

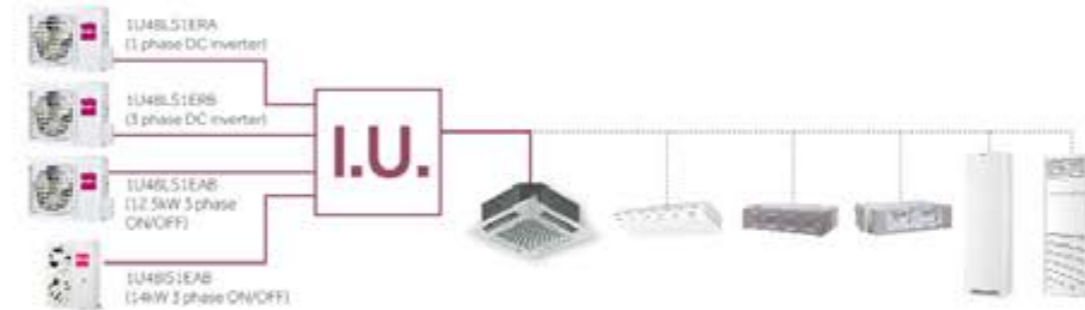

For 12k,18k,24k combination, we have totally 9 indoor units, which are three high wall type, one console type, one cassette type, one convertible type, two low ESP duct type, one middle ESP duct type. This combination can meet all installation applications.

This design is a huge Super match. This design can reduce your model stock quantity drastically.



## USER FRIENDLY

### Easy control

The universal wireless controller for high wall, console, cassette, convertible, duct can be used for everyone easily.



Separate cool, heat, dry, quiet buttons easy to use!

LIGHT COMMERCIAL DC

# CASSETTE TYPE

## CASSETTE TYPE

### NEW PANEL DESIGN

The panel dimension is 700mm×700mm, smaller and universal. Harmony with the environment. The unit dimension is 570mm×570mm×260mm for easy installation. It is universal and harmonious with standard ceiling 600mm×600mm, which avoids the breakage for ceiling during installation.



### QUIET OPERATION

The fan blade adopts the design of irregular helix, the indoor unit can run at the lowest sound level.



### BUILT-IN HIGH HEAD DRAIN PUMP

A standard drain-head height up to 600mm is possible, creating the ideal solution for perfect water drainage.



### COMPACT DESIGN

Adopts compact design, the thickness of the main body is only 24cm. Even if the inner space of ceiling is narrow, the unit can also be installed easily.

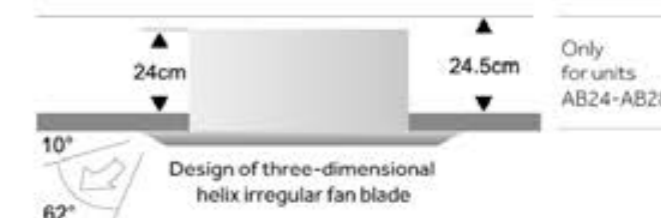

### FRESH AIR INLET (AB12~AB18, AB36~AB60)

Pre-set fresh air inlet can introduce the outside fresh air into the room, greatly improve the indoor air quality, away from "air conditioner symptom".

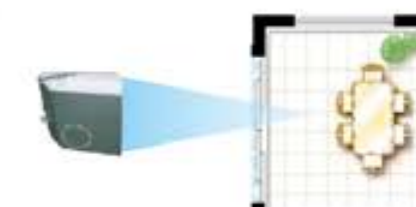

# CASSETTE TYPE



## BRANCH OUTLET

It is possible to use 1 or 2 branches for better air distribution (optional).



## COMFORTABLE TEMPERATURE CONTROL SYSTEM

3 types of swing operation for convenient in different space.

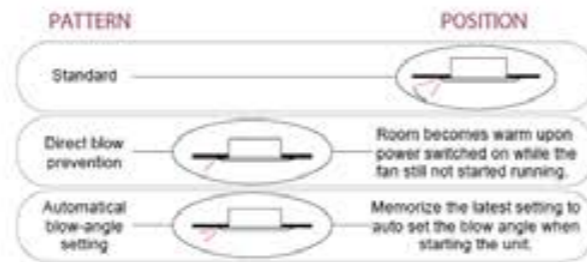

## ANTIFOULING AND MOVABLE BLADE

The movable blade has antifouling design and can effectively control the airflow and air direction. It is clean to use without polluting the ceiling. It has standard long acting filter screen to make the cleaning time largely extended. When there are many units, the operation of cleaning and maintenance will be largely reduced.

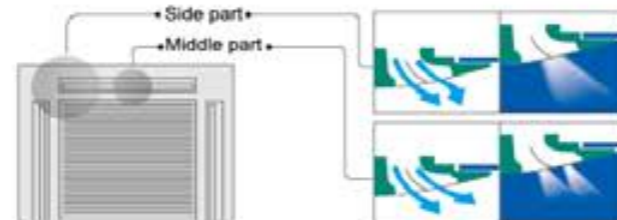

## ADVANCED STRUCTURE FACILITATING CLEANING AND INSTALLATION

The suction grille can be rotated by 90 degree and its installation direction can be selected randomly.

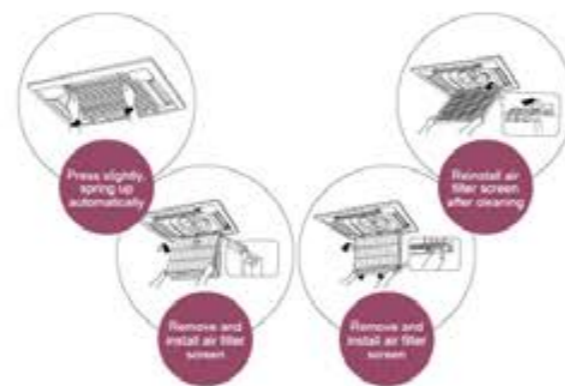

180° sine wave DC Inverter

- AB12CS1ERA
- AB18CS1ERA
- AB24ES1ERA



Model/Indoor unit		AB12CS1ERA	AB18CS1ERA	AB24ES1ERA		
Capacity	Cooling	Btu/h(nor)	12000	17000	22200	
	Heating	kW nor(min-max)	3.5(0.9-4.5)	5(1.8-5.8)	6.5(2-7.3)	
		Btu/h(nor)	12600	18800	24300	
Electrical parameters	Heating P design (-10°C)	kW	3.4	5.1	5.1	
		Power supply	Ph/V/Hz	1/230/50/60	1/230/50/60	1/230/50/60
	Power input	Cooling	kW nor(min-max)	1.06(0.28-1.65)	1.53(0.55-2)	2.02(0.5-2.6)
		Heating	kW nor(min-max)	0.99(0.28-1.65)	1.52(0.6-2)	1.91(0.5-2.6)
Performance	EER/COP		3.31/3.71	3.26/3.42	3.23/3.72	
	SEER/SCOP		5.6/3.8	5.6/3.4	5.2/3.8	
	Energy class (Cooling/Heating)		A+/A	A+/A	A/A	
	Air flow (H/M/L)	m³/h	620/520/450	700/620/500	1300/1100/870	
	Sound power level (H/M/L)	dB(A)	53/49/45	55/50/47	59/57/52	
	Sound pressure level (H/M/L)	dB(A)	40/36/32	42/37/35	46/44/39	
	Installation	External dimensions (W/D/H)	mm	570/570/260	570/570/260	840/840/240
		Shipping dimensions (W/D/H)	mm	718/680/380	718/680/380	930/930/330
		Net/Shipping weight	kg	18.5/23	18.5/23	26.8/32.6
	Controller	Wired(O-optional/S-standard)		YR-E14(O)	YR-E14(O)	YR-E14(O)
Infrared(O-optional/S-standard)			YR-HD(S)	YR-HD(S)	YR-HD(S)	
Panel	Model		PB-700IB	PB-700IB	PB-950JB	
	External dimensions (W/D/H)	mm	700/700/60	700/700/60	950/950/60	
	Shipping dimensions (W/D/H)	mm	740/750/115	740/750/115	985/985/115	
	Net/Shipping weight	kg	2.8/4.8	2.8/4.8	4.2/6.3	
Model/Outdoor unit		1U12B52ERA	1U18F52ERA	1U24G51ERA		
Electrical parameters	Power supply	Ph/V/Hz	1/230/50	1/230/50	1/230/50/60	
	Air flow (H)	m³/h	2000	2200	3000	
Performance	Sound power level	dB(A)	61/56/52/49	63/60/57/54	68	
	Sound pressure level	dB(A)	51/46/42/39	53/50/47/44	57	
	External dimensions (W/D/H)	mm	780/245/540	810/288/688	860/308/730	
	Shipping dimensions (W/D/H)	mm	930/340/614	949/406/745	995/420/815	
Installation	Net/Shipping weight	kg	32/35	45/45.5	49/52	
	Compressor type		Rotary	Twin Rotary	Rotary	
	Refrigerant type		R410A	R410A	R410A	
	Refrigerant liquid pipe	mm	6.35	6.35	9.52	
	Refrigerant gas pipe	mm	9.52	12.7	15.88	
	Max pipe length	m	15	25	25	
	Max drop between I.U.&O.U.	m	10	15	15	
	Working temp	Cooling (Min-Max)	°C	18-43	18-43	-10-46
Heating (Min-Max)		°C	-15-24	-15-24	-15-24	

\* Model is under development, data is for reference.

# CASSETTE TYPE

180° sine wave DC inverter

- AB28ES1ERA
- AB36ES1ERA



Model/Indoor unit			AB28ES1ERA	AB36ES1ERA
Capacity	Cooling	Btu/h(nor)	27500	32400
		kW(nor/min-max)	8.0(2.2-9.5)	9.5(2.2-11.2)
	Heating	Btu/h(nor)	31000	34450
		kW(nor/min-max)	9.1(2.5-10.0)	10.1(2.5-11.8)
Electrical parameters	Heating P design (-10°C)	kW	6.6	7.6
	Power supply	Ph/V/Hz	1/230/50/60	1/230/50/60
	Power input	Cooling kW(nor/min-max)	2.49(0.5-3.8)	2.49(0.5-3.8)
		Heating kW(nor/min-max)	2.67(0.5-3.8)	2.80(0.5-3.8)
Performance	EER/COP		3.21/3.41	3.21/3.61
	SEER/SCOP		5.1/3.4	5.2/3.8
	Energy class (Cooling/Heating)		A/A	A/A
	Air flow (H/M/L)	m³/h	1300/1100/870	1600/1450/1300
Installation	Sound power level (H/M/L)	dBA	61/59/57	62/60/57
	Sound pressure level (H/M/L)	dBA	48/46/44	49/47/44
	External dimensions (W/D/H)	mm	840/840/240	840/840/290
	Shipping dimensions (W/D/H)	mm	930/930/330	930/930/390
Controller	Net/Shipping weight	kg	26.8/32.6	38/45
	Wired(O)-optional(S)-standard(I)		YR-E14(O)	YR-E14(O)
	Infrared(O)-optional(S)-standard(I)		YR-HD(S)	YR-HD(S)
	Model		PB-950JB	PB-950JB
Panel	External dimensions (W/D/H)	mm	950/950/60	950/950/60
	Shipping dimensions (W/D/H)	mm	985/985/115	985/985/115
	Net/Shipping weight	kg	4.2/6.3	4.2/6.3
Model/Outdoor unit			1U28HS1ERA	1U36HS1ERA
Electrical parameters	Power supply	Ph/V/Hz	1/230/50/60	1/230/50/60
	Air flow (H)	m³/h	3500	3500
	Sound power level	dBA	69	69
Performance	Sound pressure level	dBA	58	58
	External dimensions (W/D/H)	mm	948/340/840	948/340/840
	Shipping dimensions (W/D/H)	mm	1040/430/1000	1040/430/1000
	Net/Shipping weight	kg	64/73	65/74
Installation	Compressor type		Rotary	Rotary
	Refrigerant type		R410A	R410A
	Refrigerant liquid pipe	mm	9.52	9.52
	Refrigerant gas pipe	mm	15.88	15.88
	Max pipe length	m	30	30
	Max drop between I.U. & O.U.	m	20	20
	Working temp	Cooling (Min-Max)	°C	-10-46
	Heating (Min-Max)	°C	-15-24	-15-24

\* Model is under development, data is for reference.

180° sine wave DC inverter

- AB48ES1ERA
- AB60CS1ERA



Model/Indoor unit			AB48ES1ERA	AB48ES1ERA	AB60CS1ERA	AB60CS1ERA
Capacity	Cooling	Btu/h(nor)	41500	41500	52200	52200
		kW(nor/min-max)	12.1(6.0-14.1)	12.1(6.0-14.1)	15.3(4.0-16.5)	15.3(4.0-16.5)
	Heating	Btu/h(nor)	44500	44500	54900	54900
		kW(nor/min-max)	13.0(6.0-16.0)	13.0(6.0-16.0)	16.3(4.0-17.5)	16.3(4.0-17.5)
Electrical parameters	Heating P design (-10°C)	kW	/	/	/	/
	Power supply	Ph/V/Hz	1/230/50/60	1/230/50/60	1/230/50	1/230/50
	Power input	Cooling kW(nor/min-max)	4.0(2.0-6.0)	4.0(2.0-6.0)	5.0(2.0-6.5)	5.0(2.0-6.5)
		Heating kW(nor/min-max)	4.0(2.0-6.0)	4.0(2.0-6.0)	5.0(2.0-6.5)	5.0(2.0-6.5)
Performance	EER/COP		3.01/3.25	3.01/3.25	3.02/3.21	3.02/3.21
	SEER/SCOP		/	/	/	/
	Energy class (Cooling/Heating)		B/C	B/C	B/C	B/C
	Air flow (H/M/L)	m³/h	1600/1450/1300	1600/1450/1300	1980/1750/1500	1980/1750/1500
Installation	Sound power level (H/M/L)	dBA	/	/	/	/
	Sound pressure level (H/M/L)	dBA	49/47/44	49/47/44	49/44/42	49/44/42
	External dimensions (W/D/H)	mm	840/840/290	840/840/290	1230/840/280	1230/840/280
	Shipping dimensions (W/D/H)	mm	930/930/390	930/930/390	1325/920/370	1325/920/370
Controller	Net/Shipping weight	kg	38/45	38/45	46/53	46/53
	Wired(O)-optional(S)-standard(I)		YR-E14(O)	YR-E14(O)	YR-E14(O)	YR-E14(O)
	Infrared(O)-optional(S)-standard(I)		YR-HD(S)	YR-HD(S)	YR-HD(S)	YR-HD(S)
	Model		PB-950JB	PB-950JB	PB-1340B	PB-1340B
Panel	External dimensions (W/D/H)	mm	950/950/60	950/950/60	1340/950/80	1340/950/80
	Shipping dimensions (W/D/H)	mm	985/985/115	985/985/115	1400/995/115	1400/995/115
	Net/Shipping weight	kg	4.2/6.3	4.2/6.3	8.4/12	8.4/12
Model/Outdoor unit			1U48LS1ERA	1U48LS1ERB	1U60LS1ERA	1U60LS1ERB
Electrical parameters	Power supply	Ph/V/Hz	1/230/50/60	3/400/50/60	1/230/50/60	3/400/50/60
	Air flow (H)	m³/h	4200	4200	6500	6500
	Sound power level	dBA	70	70	70	70
Performance	Sound pressure level	dBA	58	58	59	59
	External dimensions (W/D/H)	mm	1008/410/830	1008/410/830	948/340/1250	948/340/1250
	Shipping dimensions (W/D/H)	mm	1130/490/930	1130/490/930	1095/410/1400	1095/410/1400
	Net/Shipping weight	kg	82/93	82/93	96/106	96/106
Installation	Compressor type		Rotary	Rotary	Rotary	Rotary
	Refrigerant type		R410A	R410A	R410A	R410A
	Refrigerant liquid pipe	mm	9.52	9.52	9.52	9.52
	Refrigerant gas pipe	mm	19.05	19.05	19.05	19.05
	Max pipe length	m	50	50	50	50
	Max drop between I.U. & O.U.	m	30	30	30	30
	Working temp	Cooling (Min-Max)	°C	-10-46	-10-46	-10-46
	Heating (Min-Max)	°C	-15-24	-15-24	-15-24	-15-24

\* Model is under development, data is for reference.



### INSTALLATION FRIENDLY

The indoor unit can be installed on the floor or on the ceiling. It is determined by your actual need. It greatly decreases the space needed and also it can provide the same level of comfort. at the same time make service and installation more convenient and flexible.

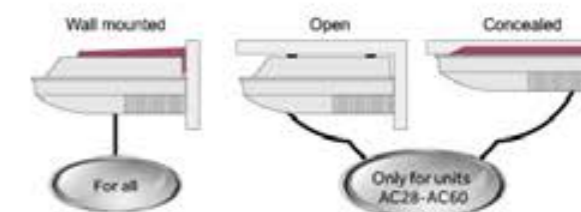

### ULTRA-THIN UNIT BODY, ONLY THICK 199MM (12K-24K)

The convertible indoor unit adopts a double drain pan design, the unit body is very thin, only 199mm. It is beautiful, elegant and space saving.



### FRESH-AIR INTAKE (28K-60K)

There are fresh air intake holes in the unit, which can make the air more comfortable.



### LARGE ANGLE AIR SUPPLYING

100° wide angle louvers and 70° wide angle blades design to make a precise control of the airflow, it equably distributes the comfortable air to every corner of the room.

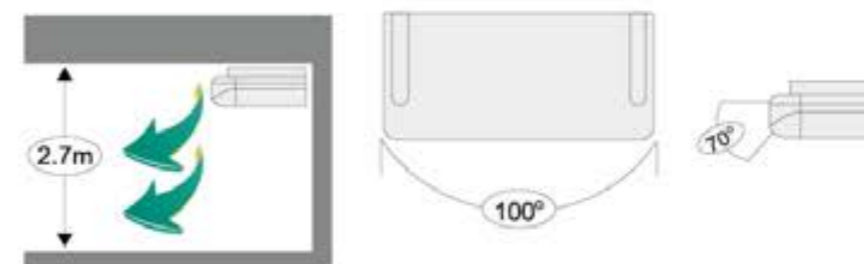

# CONVERTIBLE TYPE



## LONG-LIFE & HIGH EFFICIENCY AIR PURIFY FILTER

The unit adopts high efficiency air purify filter, greatly improves the room air quality.



## USER FRIENDLY

The filter can be easily take out, you need not take down the unit or open the air inlet grill, and realize convenient cleaning work.



## AUTOMATIC CONTROL OF AIRFLOW DIRECTION

In order to realize the comfortable space with uniform temperature, the air conditioner uses two stepping motors to adjust the airflow automatically, send the air to every corner of the room. When heating, it will supply large quantity of warm air in order to quickly and effectively warm up the floor, and it will send the airflow from top to bottom until the cool air reach every corner of the room at the cooling mode. The airflow direction can be controlled in 5 steps from up to down and from left to right, more selectable, more flexible.

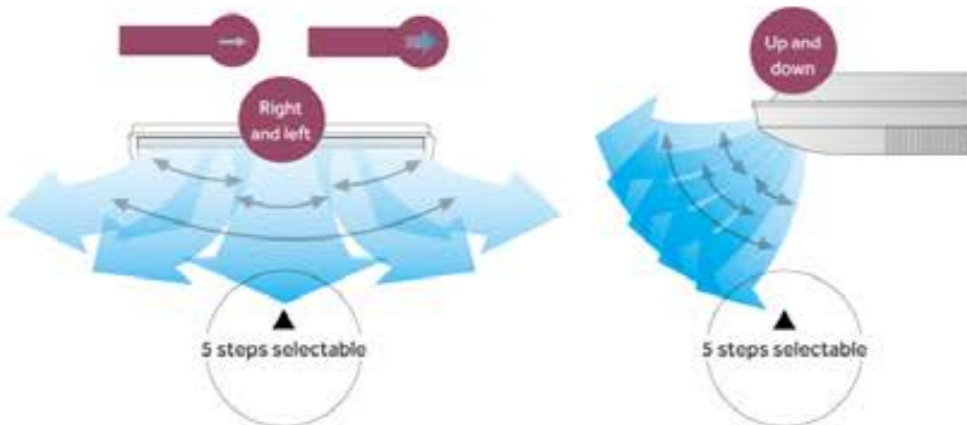

180° line wave DC inverter

- AC12CS1ERA
- AC18CS1ERA
- AC24CS1ERA



12.18.24K



Model/Indoor unit		AC12CS1ERA	AC18CS1ERA	AC24CS1ERA		
Capacity	Cooling	Btu/h(nor)	12000	17000	22200	
		kW(nor(min-max))	3.5(0.9-4.5)	5(1.8-5.8)	6.3(2~7.3)	
	Heating	Btu/h(nor)	13300	18700	24300	
		kW(nor(min-max))	3.9(1-4.8)	5.5(2-6.5)	7.1(2.5~8.0)	
Electrical parameters	Heating P design (-10°C)	kW	3.4	5.1	5.1	
	Power supply	Ph/V/Hz	1/230/50/60	1/230/50/60	1/230/50/60	
	Power input	Cooling	kW(nor(min-max))	1.03(0.28-1.65)	1.53(0.55-2)	2.14(0.5~2.6)
		Heating	kW(nor(min-max))	1.02(0.28-1.65)	1.48(0.6-2)	2.08(0.5~2.6)
Performance	EER/SCOP		3.39/3.81	3.26/3.72	3.01/3.41	
	SEER/SCOP		5.3/3.8	5.7/3.6	5.4/3.6	
	Energy class (Cooling/Heating)		A/A	A+/A	A/A	
Installation	Air flow (l/s/M/L)	m³/h	650/550/450	800/720/650	850/800/720	
	Sound power level (H/M/L)	dB(A)	54/50/46	57/54/49	57/54/49	
	Sound pressure level (H/M/L)	dB(A)	41/37/33	44/41/36	44/41/36	
Controller	External dimensions (W/D/H)	mm	990/655/199	990/655/199	990/655/199	
	Shipping dimensions (W/D/H)	mm	1150/750/300	1150/750/300	1150/750/300	
	Net/Shipping weight	kg	28.3/32.3	28.3/34.3	28.3/34.3	
Model/Outdoor unit	Wired/O-option/S-standard		YR-E14(O)	YR-E14(O)	YR-E14(O)	
	Infrared/O-option/S-standard		YR-HD(S)	YR-HD(S)	YR-HD(S)	
Performance	Power supply	Ph/V/Hz	1/230/50	1/230/50	1/230/50/60	
	Air flow (l/s)	m³/h	2000	2200	3000	
	Sound power level	dB(A)	61/56/52/49	63/60/57/54	68	
	Sound pressure level	dB(A)	51/46/42/39	53/50/47/44	57	
Installation	External dimensions (W/D/H)	mm	780/245/540	810/288/688	860/308/730	
	Shipping dimensions (W/D/H)	mm	930/340/614	949/406/745	995/420/815	
	Net/Shipping weight	kg	32/35	43/45.5	49/52	
	Compressor type		Rotary	Twin Rotary	Rotary	
Working temp.	Refrigerant type		R410A	R410A	R410A	
	Refrigerant liquid pipe	mm	6.35	6.35	9.52	
	Refrigerant gas pipe	mm	9.52	12.7	15.88	
	Max pipe length	m	15	25	25	
Working temp.	Max drop between I.U.&O.U	m	10	15	15	
	Cooling (Min-Max)	°C	18-43	18-43	-10-46	
	Heating (Min-Max)	°C	-15-24	-15-24	-15~24	

\* Model is under development, data is for reference

# CONVERTIBLE TYPE

180° sine wave DC inverter

AC28ES1ERA  
AC36ES1ERA



28.36K



28.36K



Model/Indoor unit		AC28ES1ERA	AC36ES1ERA	
Capacity	Cooling	Btu/h(nor)	34000	
		kW(nor/min-max)	10.0(2.2-11.0)	
	Heating	Btu/h(nor)	36100	
		kW(nor/min-max)	10.6(2.2-11.8)	
Electrical parameters	Heating P design (-10°C)	kW	7.6	
	Power supply	Ph/V/Hz	1/230/50/60	
	Power input	Cooling	kW(nor/min-max)	2.35(0.5-2.6)
		Heating	kW(nor/min-max)	2.94(0.5-3.8)
Performance	EER/COP		4.0/3.61	
	SEER/SCOP		5.8/3.8	
	Energy class (Cooling/Heating)		A+/A	
	Air flow (l/h/M/L)	m³/h	1630/1537/1375	
Installation	Sound power level (l/h/M/L)	dB(A)	62/58/56	
	Sound pressure level (l/h/M/L)	dB(A)	49/45/43	
	External dimensions (W/D/H)	mm	1298/700/240	
	Shipping dimensions (W/D/H)	mm	1500/790/315	
Controller	Net/Shipping weight	kg	37/47	
	Wired(O-option)S-standard)	YR-E14(O)	YR-E14(O)	
	Infrared(O-option)S-standard)	YR-HD(S)	YR-HD(S)	
Model/Outdoor unit		1U28HS1ERA	1U36HS1ERA	
Electrical parameters	Power supply	Ph/V/Hz	1/230/50/60	
	Air flow (l/h)	m³/h	3500	
Performance	Sound power level	dB(A)	69	
	Sound pressure level	dB(A)	58	
Installation	External dimensions (W/D/H)	mm	948/340/840	
	Shipping dimensions (W/D/H)	mm	1040/430/1000	
	Net/Shipping weight	kg	64/73	
	Compressor type		Rotary	
Working temp.	Refrigerant type		R410A	
	Refrigerant liquid pipe	mm	9.52	
	Refrigerant gas pipe	mm	15.88	
	Max pipe length	m	30	
	Max drop between I.U.&O.U	m	20	
	Cooling (Min-Max)	°C	-10-46	
	°C	-15-24		

\* Model is under development, data is for reference.

180° sine wave DC inverter

AC48FS1ERA  
AC60FS1ERA



48K



60K



48.60K



Model/Indoor unit		AC48FS1ERA	AC48FS1ERA	AC60FS1ERA	AC60FS1ERA	
Capacity	Cooling	Btu/h(nor)	42650	42650	52900	
		kW(nor/min-max)	12.5(6.0-14.5)	12.5(6.0-14.5)	15.5(4.0-16.5)	
	Heating	Btu/h(nor)	48100	48100	56300	
		kW(nor/min-max)	14.1(6.0-16.5)	14.1(6.0-16.5)	16.5(4.0-18.0)	
Electrical parameters	Heating P design (-10°C)	kW	7.6	7.6	9.5	
	Power supply	Ph/V/Hz	1/230/50/60	1/230/50/60	1/230/50/60	
	Power input	Cooling	kW(nor/min-max)	3.89(2.0-6.0)	3.89(2.0-6.0)	5.14(2.0-6.5)
		Heating	kW(nor/min-max)	4.10(2.0-6.0)	4.10(2.0-6.0)	4.83(2.0-6.5)
Performance	EER/COP		3.21/3.44	3.21/3.44	3.02/3.42	
	SEER/SCOP		/	/	/	
	Energy class (Cooling/Heating)		A/B	A/B	B/B	
	Air flow (l/h/M/L)	m³/h	2000/1800/1400	2000/1800/1400	2000/1800/1400	
Installation	Sound power level (l/h/M/L)	dB(A)	/	/	/	
	Sound pressure level (l/h/M/L)	dB(A)	53/51/49	53/51/49	53/51/49	
	External dimensions (W/D/H)	mm	1580/700/240	1580/700/240	1580/700/240	
	Shipping dimensions (W/D/H)	mm	1710/790/315	1710/790/315	1710/790/315	
Controller	Net/Shipping weight	kg	54/61	54/61	54/61	
	Wired(O-option)S-standard)	YR-E14(O)	YR-E14(O)	YR-E14(O)	YR-E14(O)	
	Infrared(O-option)S-standard)	YR-HD(S)	YR-HD(S)	YR-HD(S)	YR-HD(S)	
Model/Outdoor unit		1U48LS1ERA	1U48LS1ERB	1U60LS1ERA	1U60LS1ERB	
Electrical parameters	Power supply	Ph/V/Hz	1/230/50/60	3/400/50/60	1/230/50/60	3/400/50/60
	Air flow (l/h)	m³/h	4200	4200	6500	6500
Performance	Sound power level	dB(A)	70	70	70	70
	Sound pressure level	dB(A)	59	59	60	60
Installation	External dimensions (W/D/H)	mm	1008/410/830	1008/410/830	948/340/1250	948/340/1250
	Shipping dimensions (W/D/H)	mm	1130/490/930	1130/490/930	1095/410/1400	1095/410/1400
	Net/Shipping weight	kg	82/93	82/93	96/106	96/106
	Compressor type		Rotary	Rotary	Rotary	Rotary
	Refrigerant type		R410A	R410A	R410A	R410A
	Refrigerant liquid pipe	mm	9.52	9.52	9.52	9.52
Working temp.	Refrigerant gas pipe	mm	19.05	19.05	19.05	19.05
	Max pipe length	m	50	50	50	50
	Max drop between I.U.&O.U	m	30	30	30	30
	Cooling (Min-Max)	°C	-10-46	-10-46	-10-46	-10-46
	°C	-15-24	-15-24	-15-24	-15-24	

\* Model is under development, data is for reference.



### KNOCK-DOWN DRAIN PAN & DOUBLE SIDES WATER DRAINAGE

The drain pan is easy to disassemble, and it can realize the two sides drainage through changing the direction of the drain pan.

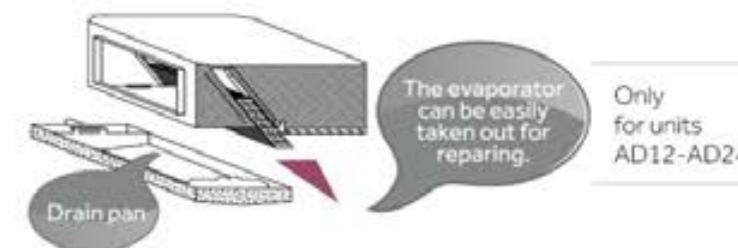

### SPECIAL UP-DRAINAGE WATER PUMP

The unit has a water pump whose the max. drainage height can be up to 600mm.

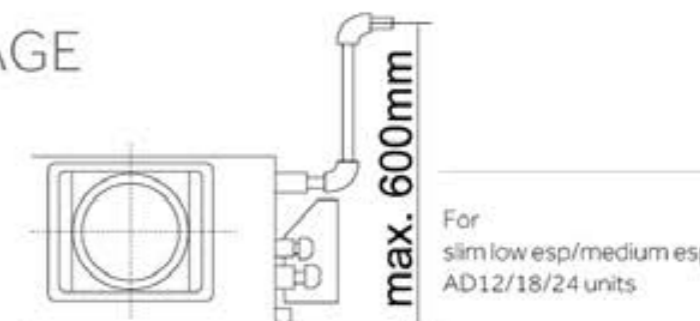

### HIGH EFFICIENCY FILTER

The unit adopts G3 grade filter which can efficiently filter the dirt etc., and improve the room air quality. At the same time, the filter can be pulled out from downside, convenient for maintenance and cleaning.



### SUPER THIN DESIGN

185mm super thin design, which is advanced in the industry, make the silmest ceiling drop.





180° sine wave DC inverter

- AD12LS1ERA
- AD18LS1ERA
- AD24LS1ERA

## FREE SETTING OF AIR DISCHARGE DUCT

The number of the airflow outlet and its installation position can be freely selected according to the surrounding of the room, sufficiently considering the load of the room and the uniform temperature of the room to realize more perfect comfort.



## USER FRIENDLY

The indoor unit can use one wired remote controller, also, it can use a remote controller (with new remote receiver) (optional).

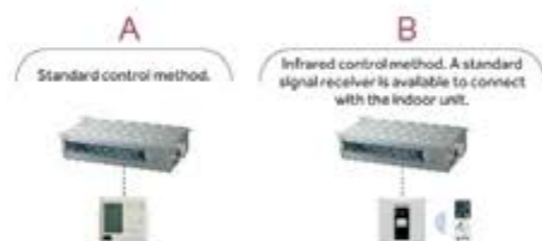

## INSTALLATION FRIENDLY

ESP can be adjusted from 50pa-150Pa steplessly, this feature is fit for different ESP installation need, save the static pressure box cost for the end user, also save the static pressure box installation for the installer. (AD48/60HS1ERA)



## MULTI-MODE FOR INSTALLATION

The indoor unit can be installed with an air return duct or without an air return duct according to the installation need.



## DESIGN FRIENDLY

There are low/middle/high static pressure duct models fit for different design application.

**Low ESP duct:** 0/30Pa selectable



**Middle ESP duct:** 0/50Pa selectable (12K-24K)



50Pa/100Pa selectable (28K-48K)



**High ESP duct:** 50Pa-150Pa adjustable steplessly (48K-60K)



Model/Indoor unit		AD12LS1ERA	AD18LS1ERA	AD24LS1ERA
Capacity	Cooling	Btu/h(nor) 12000	17000	25200
	Heating	kW nor(min-max) 3.5(0.9-4.5)	5(1.8-6)	6.8(2-7.6)
Electrical parameters	Power supply	Ph/V/Hz 1/230/50/60	1/230/50/60	1/230/50/60
	Power input	Cooling kW nor(min-max) 1.03(0.28-1.65)	1.53(0.55-2.1)	2.1(0.6-2.6)
Performance	External static pressure	Pa 0/25	0/25	0/25
	Sound power level (H/M/L)	dB(A) 50/47/44	54/48/45	59/55/51
Installation	External dimensions (W/D/H)	mm 610/484/220	1090/484/220	1090/484/220
	Shipping dimensions (W/D/H)	mm 710/545/280	1174/545/280	1174/545/280
Controller	Wired(O-optional S-standard)	YR-E14(S)	YR-E14(S)	YR-E14(S)
	Infrared(O-optional S-standard)	YR-HD(O)	YR-HD(O)	YR-HD(O)
Model/Outdoor unit		1U12BS2ERA	1U18FS2ERA	1U24GS1ERA
Performance	Sound power level	dB(A) 61/56/52/49	65/60/57/54	68
	Sound pressure level (H/M/L)	dB(A) 51/46/42/39	55/50/47/44	57
Installation	External dimensions (W/D/H)	mm 780/245/540	810/288/688	860/308/730
	Shipping dimensions (W/D/H)	mm 930/340/614	949/406/745	995/420/815
Working temp	Cooling (Min-Max)	°C 18-43	18-43	-10-46
	Heating (Min-Max)	°C -15-24	-15-24	-15-24

\* Model is under development, data is for reference.

# Slim Low ESP DUCT



# Medium ESP DUCT

180° sine wave DC inverter

- AD12SS1ERA
- AD18SS1ERA
- AD24SS1ERA



Model/Indoor unit			AD12SS1ERA	AD18SS1ERA	AD24SS1ERA
Capacity	Cooling	Btu/h(nor)	12000	17000	23200
		kW nor(min-max)	3.5(0.9-4.5)	5(1.8-6)	6.8(2-7.6)
	Heating	Btu/h(nor)	13700	18800	24200
		kW nor(min-max)	4.0(1-4.8)	5.5(2-6.2)	7.1(3-8.3)
Electrical parameters	Heating P design (-10°C)	kW	3.4	5.1	5.2
	Power supply	Ph/V/Hz	1/230/50/60	1/230/50/60	1/230/50/60
	Power input	Cooling kW nor(min-max)	1.03(0.28-1.65)	1.53(0.55-2.1)	2.1(0.6-2.6)
		Heating kW nor(min-max)	1.07(0.28-1.65)	1.47(0.6-2.1)	1.91(0.6-2.6)
Performance	EER/CCP		3.39/3.73	3.26/3.73	3.24/3.72
	SEER/SCOP		5.6/3.8	5.8/3.8	5.6/3.8
	Energy class (Cooling/Heating)		A+/A	A+/A	A+/A
	Air flow (H/M/L)	m³/h	550	900	1100
Installation	External dimensions (W/D/H)	mm	850/420/185	1170/420/185	1170/420/185
	Shipping dimensions (W/D/H)	mm	1025/525/260	1345/525/260	1345/525/260
	Net/Shipping weight	kg	17/18	25/26.5	27/28.5
	Controller	Wired(O-optional,S-standard) Infrared(O-optional,S-standard)		YR-E14(S) YR-HD(O)	YR-E14(S) YR-HD(O)
Model/Outdoor unit			1U12BS2ERA	1U18FS2ERA	1U24GS1ERA
Electrical parameters	Power supply	Ph/V/Hz	1/230/50	1/230/50	1/230/50/60
	Air flow (H)	m³/h	2000	2200	3000
	Sound power level	dB(A)	61/56/52/49	63/60/57/54	68
	Sound pressure level	dB(A)	51/46/42/39	53/50/47/44	57
Installation	External dimensions (W/D/H)	mm	780/245/540	810/288/688	860/308/730
	Shipping dimensions (W/D/H)	mm	930/340/614	949/406/745	995/420/815
	Net/Shipping weight	kg	32/35	43/45.5	49/52
	Compressor type		Rotary	Twin Rotary	Rotary
Working temp.	Refrigerant type		R410A	R410A	R410A
	Refrigerant liquid pipe	mm	6.35	6.35	9.52
	Refrigerant gas pipe	mm	9.52	12.7	15.88
	Max pipe length	m	15	25	25
	Max drop between I.U.&O.U.	m	10	15	15
	Cooling (Min-Max)	°C	18-43	18-43	-10-46
Heating (Min-Max)	°C	-15-24	-15-24	-15-24	

\* Model is under development, data is for reference.

180° sine wave DC inverter

- AD12MS1ERA
- AD18MS1ERA
- AD24MS1ERA



Model/Indoor unit			AD12MS1ERA	AD18MS1ERA	AD24MS1ERA
Capacity	Cooling	Btu/h(nor)	12000	17000	24000
		kW nor(min-max)	3.5(0.9-4.5)	5(1.8-6)	7.1(2.0-8.2)
	Heating	Btu/h(nor)	13700	18800	25600
		kW nor(min-max)	4.0(1-4.8)	5.5(2-6.2)	7.5(2.5-8.5)
Electrical parameters	Heating P design (-10°C)	kW	3.4	5.1	5.2
	Power supply	Ph/V/Hz	1/230/50/60	1/230/50/60	1/230/50/60
	Power input	Cooling kW nor(min-max)	1.03(0.28-1.65)	1.53(0.55-2.1)	2.19(0.6-2.6)
		Heating kW nor(min-max)	1.07(0.28-1.65)	1.47(0.6-2.1)	2.02(0.6-2.6)
Performance	EER/CCP		3.23/3.71	3.23/3.71	3.23/3.71
	SEER/SCOP		5.8/3.8	5.8/3.8	5.6/3.8
	Energy class (Cooling/Heating)		A+/A	A+/A	A+/A
	Air flow (H/M/L)	m³/h	550/450/400	880/810/650	1050/1000/900
Installation	External static pressure	Pa	0/50	0/50	0/50
	Sound power level (H/M/L)	dB(A)	56/54/51	56/54/51	56/54/51
	Sound pressure level (H/M/L)	dB(A)	44/42/39	44/42/39	44/42/39
	External dimensions (W/D/H)	mm	720/650/270	720/650/270	950/650/270
Controller	Shipping dimensions (W/D/H)	mm	940/860/340	940/860/340	1170/860/340
	Net/Shipping weight	kg	28/30	28/30	37/39
Model/Outdoor unit			1U12BS2ERA	1U18FS2ERA	1U24GS1ERA
Electrical parameters	Power supply	Ph/V/Hz	1/230/50	1/230/50	1/230/50/60
	Air flow (H)	m³/h	2000	2200	3000
	Sound power level	dB(A)	61/56/52/49	63/60/57/54	68
	Sound pressure level	dB(A)	51/46/42/39	53/50/47/44	57
Working temp.	External dimensions (W/D/H)	mm	780/245/540	810/288/688	860/308/730
	Shipping dimensions (W/D/H)	mm	930/340/614	949/406/745	995/420/815
	Net/Shipping weight	kg	32/35	43/45.5	49/52
	Compressor type		Rotary	Twin Rotary	Rotary
	Refrigerant type		R410A	R410A	R410A
	Refrigerant liquid pipe	mm	6.35	6.35	9.52
Refrigerant gas pipe	mm	9.52	12.7	15.88	
Max pipe length	m	15	25	25	
Max drop between I.U.&O.U.	m	10	15	15	
Cooling (Min-Max)	°C	18-43	18-43	-10-46	
Heating (Min-Max)	°C	-15-24	-15-24	-15-24	

\* Model is under development, data is for reference.

# Medium ESP DUCT



# High ESP DUCT

180° sine wave DC inverter

- AD28NS1ERA
- AD36NS1ERA
- AD48NS1ERA



28.36.48k



28.36k



48k



60k

- High performance compressor
- 180° sine wave DC inverter
- Auto mode
- Power mode
- On-Off card
- Group control
- Central control
- Comfortable sleep
- Quiet operation
- Auto restart
- 3 minutes protection
- Weekly timer
- 24 hours timer
- Super match

Model/Indoor unit		AD28NS1ERA	AD36NS1ERA	AD48NS1ERA	AD48NS1ERA	
Capacity	Cooling	Btu/h(nor)	29000	34000	41650	
	Heating	kW(nor/min-max)	8.5(2.1-9.8)	9.9(2.2-11.0)	12.5(6.0-14.5)	
		Btu/h(nor)	32400	36100	48100	
Electrical parameters	Heating P design (-10°C)	kW	6.6	7.6	8.8	
		Power supply	PhV/Hz	1/230/50/60	1/230/50/60	1/230/50/60
	Power input	Cooling	kW(nor/min-max)	2.65(0.5-3.8)	3.29(0.5-3.8)	4.15(2.0-6.0)
		Heating	kW(nor/min-max)	2.65(0.5-3.8)	3.05(0.5-3.8)	3.9(2.0-6.0)
	EER/COP	Cooling		3.21/3.61	3.01/3.61	3.01/3.62
		Heating		5.4/3.5	5.3/3.4	/
	Energy class (Cooling/Heating)		A/A	A/A	B/A	B/A
		Air flow (H/M/L)	m³/h	2090/1970/1792	2090/1970/1792	2090/1970/1792
	Performance	External static pressure	Pa	50/100	50/100	50/100
		Sound power level (H/M/L)	dB(A)	63/61/59/55	63/61/59/55	/
Sound pressure level (H/M/L)		dB(A)	50/48/46/42	50/48/46/42	51/49/47/43	
Installation	External dimensions (W/D/H)	mm	1135/742/270	1135/742/270	1135/742/270	
	Shipping dimensions (W/D/H)	mm	1300/850/380	1300/850/380	1300/850/380	
	Net/Shipping weight	kg	52/55	52/55	52/55	
Controller	Wired(O-optional S-standard)		YR-E14(S)	YR-E14(S)	YR-E14(S)	
	Infrared(O-optional S-standard)		YR-HD(O)	YR-HD(O)	YR-HD(O)	
Model/Outdoor unit		1U28HS1ERA	1U36HS1ERA	1U48LS1ERA	1U48LS1ERB	
Electrical parameters	Power supply	PhV/Hz	1/230/50/60	1/230/50/60	1/230/50/60	
	Air flow (H)	m³/h	3500	3500	4200	
Performance	Sound power level	dB(A)	69	69	70	
	Sound pressure level	dB(A)	58	58	59	
	External dimensions (W/D/H)	mm	948/340/840	948/340/840	1008/410/830	
Installation	Shipping dimensions (W/D/H)	mm	1040/430/1000	1040/430/1000	1130/490/930	
	Net/Shipping weight	kg	64/73	65/74	82/93	
	Compressor type		Rotary	Rotary	Rotary	
	Refrigerant type		R410A	R410A	R410A	
	Refrigerant liquid pipe	mm	9.52	9.52	9.52	
	Refrigerant gas pipe	mm	15.88	15.88	19.05	
	Max pipe length	m	30	30	50	
	Max drop between I.U.&O.U	m	20	20	30	
	Working temp.	Cooling (Min-Max)	°C	-10-46	-10-46	-10-46
		Heating (Min-Max)	°C	-15-24	-15-24	-15-24

\* Model is under development, data is for reference.

180° sine wave DC inverter

- AD48HS1ERA
- AD60HS1ERA



48.60k

- High performance compressor
- 180° sine wave DC inverter
- Auto mode
- Power mode
- On-Off card
- Group control
- Central control
- Comfortable sleep
- Quiet operation
- Auto restart
- 3 minutes protection
- Weekly timer
- 24 hours timer
- Super match

Model/Indoor unit		AD48HS1ERA	AD48HS1ERA	AD60HS1ERA	AD60HS1ERA	
Capacity	Cooling	Btu/h(nor)	42660	42660	52900	
	Heating	kW(nor/min-max)	12.5(6.0-14.5)	12.5(6.0-14.5)	15.5(4.0-16.5)	
		Btu/h(nor)	48100	48100	56300	
Electrical parameters	Heating P design (-10°C)	kW	/	/	/	
		Power supply	PhV/Hz	1/230/50/60	1/230/50/60	1/230/50/60
	Power input	Cooling	kW(nor/min-max)	4.15(2.0-6.0)	4.15(2.0-6.0)	5.13(2.0-6.5)
		Heating	kW(nor/min-max)	3.9(2.0-6.0)	3.9(2.0-6.0)	4.57(2.0-6.5)
	EER/COP	Cooling		3.01/3.62	3.01/3.62	3.02/3.61
		Heating		/	/	/
	Energy class (Cooling/Heating)		B/A	B/A	B/A	B/A
		Air flow (H/M/L)	m³/h	2580/2070/1560	2580/2070/1560	2580/2070/1560
	Performance	External static pressure	Pa	50-150	50-150	50-150
		Sound power level (H/M/L)	dB(A)	/	/	/
Sound pressure level (H/M/L)		dB(A)	50/46/42	50/46/42	50/46/42	
Installation	External dimensions (W/D/H)	mm	1197/830/360	1197/830/360	1197/830/360	
	Shipping dimensions (W/D/H)	mm	1430/940/420	1430/940/420	1430/940/420	
	Net/Shipping weight	kg	54/61	54/61	54/61	
Controller	Wired(O-optional S-standard)		YR-E14(S)	YR-E14(S)	YR-E14(S)	
	Infrared(O-optional S-standard)		YR-HD(O)	YR-HD(O)	YR-HD(O)	
Model/Outdoor unit		1U48LS1ERA	1U48LS1ERB	1U60LS1ERA	1U60LS1ERB	
Electrical parameters	Power supply	PhV/Hz	1/230/50/60	1/230/50/60	1/230/50/60	
	Air flow (H)	m³/h	4200	4200	6500	
Performance	Sound power level	dB(A)	70	70	70	
	Sound pressure level	dB(A)	59	59	60	
	External dimensions (W/D/H)	mm	1008/410/830	1008/410/830	948/340/1250	
Installation	Shipping dimensions (W/D/H)	mm	1130/490/930	1130/490/930	1095/410/1400	
	Net/Shipping weight	kg	82/93	82/93	96/106	
	Compressor type		Rotary	Rotary	Rotary	
	Refrigerant type		R410A	R410A	R410A	
	Refrigerant liquid pipe	mm	9.52	9.52	9.52	
	Refrigerant gas pipe	mm	19.05	19.05	19.05	
	Max pipe length	m	50	50	50	
	Max drop between I.U.&O.U	m	30	30	30	
	Working temp.	Cooling (Min-Max)	°C	-10-46	-10-46	-10-46
		Heating (Min-Max)	°C	-15-24	-15-24	-15-24

\* Model is under development, data is for reference.



LIGHT COMMERCIAL DC

**cabinet** TYPE

**cabinet** TYPE

### NEW AIR INLET DESIGN

Side air inlet, different from downside air inlet, the downside panel is new flat look & easy clean.



### 15M LONG DISTANCE AIRFLOW SUPPLY

According to the requirement of office room and large parlor, 15m long distance and 160 degree wide-angle airflow supply.



### WIDE ANGLE 160° AIR SENDING

Rounding 3-dimensional, 160 wide angle air sending, reach every corner of the room.

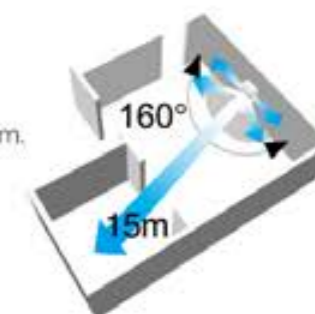

### LCD DISPLAY

Be displayed on the LCD screen, perfect design.



### QUIET OPERATION

Adopting optimum designed blower & new designed insulation material, realizing indoor low noise running, outdoor unit with well-known brand compressor, reducing the operation noise.

### ROUNDING NATURAL AIR, KEEPING AWAY FROM "AIR CONDITIONER SYMPTOM"

Apply innovative natural rounding air technology, simulating natural frequency spectrum, adjusting fan speed at random, three dimensions air scanning and natural air delivering, not blowing to human body, more convenient and comfort.



# Cabinet TYPE

# Control System

180° sine wave DC inverter

- AP48DS1ERA
- AP60KS1ERA
- AP48KS1ERA



Model/Indoor unit			AP48DS1ERA	AP48DS1ERA	AP48KS1ERA	AP48KS1ERA	AP60KS1ERA	AP60KS1ERA	
Capacity	Cooling	Btu/h(nor)	42660	42660	42660	42660	52900	52900	
		kW(nor/min-max)	12.5(6.0-14.5)	12.5(6.0-14.5)	12.5(6.0-14.5)	12.5(6.0-14.5)	15.5(4.0-16.5)	15.5(4.0-16.5)	
	Heating	Btu/h(nor)	48100	48100	48100	48120	56300	56300	
Electrical parameters	Power supply	PhV/Hz	1/230/50	1/230/50	1/230/50	1/230/50	1/230/50	1/230/50	
	Power input	Cooling	kW(nor/min-max)	3.84(2.0-6.0)	3.90(2.0-6.0)	3.84(2.0-6.0)	3.90(2.0-6.0)	5.13(2.0-6.5)	5.13(2.0-6.5)
		Heating	kW(nor/min-max)	3.81(2.0-6.0)	3.81(2.0-6.0)	3.81(2.0-6.0)	3.81(2.0-6.0)	4.83(2.0-6.5)	4.83(2.0-6.5)
Performance	EER/COF		3.25/3.41	3.21/3.41	3.25/3.41	3.21/3.41	3.02/3.21	3.02/3.21	
	SEER/SCOP		A/B	A/B	A/B	A/B	B/C	B/C	
	Energy class(Cooling/Heating)		A/B	A/B	A/B	A/B	B/C	B/C	
Installation	Air flow (H/M/L)	m³/h	1750/1500/1350	1750/1500/1350	1750/1500/1350	1750/1500/1350	1750/1500/1350	1750/1500/1350	
	Sound power level (H/M/L)	dB(A)	48/44/40	48/44/40	51/48/44	51/48/44	51/48/44	51/48/44	
	Sound pressure level (H/M/L)	dB(A)	48/44/40	48/44/40	51/48/44	51/48/44	51/48/44	51/48/44	
Controller	External dimensions (W/D/H)	mm	1824/529/380	1824/529/380	1850/600/350	1850/600/350	1850/600/350	1850/600/350	
	Shipping dimensions (W/D/H)	mm	1965/625/465	1965/625/465	1980/660/420	1980/660/420	1980/660/420	1980/660/420	
	Net/Shipping weight	kg	55/62	55/62	59/70	59/70	59/70	59/70	
Model/Outdoor unit			1U48LS1ERA	1U48LS1ERB	1U48LS1ERA	1U48LS1ERB	1U60IS1ERA	1U60IS1ERB	
Performance	Power supply	PhV/Hz	1/230/50/60	3/400/50/60	1/230/50/60	3/400/50/60	1/230/50/60	3/400/50/60	
	Air flow (H)	m³/h	4200	4200	4200	4200	6500	6500	
	Sound power level	dB(A)	70	70	70	70	70	70	
Installation	Sound pressure level	dB(A)	59	59	59	59	60	60	
	External dimensions (W/D/H)	mm	1008/410/830	1008/410/830	1008/410/830	1008/410/830	948/340/1250	948/340/1250	
	Shipping dimensions (W/D/H)	mm	1150/490/930	1150/490/930	1150/490/930	1150/490/930	1095/410/1400	1095/410/1400	
Working temp.	Net/Shipping weight	kg	82/93	82/93	82/93	82/93	96/106	96/106	
	Compressor type		Rotary	Rotary	Rotary	Rotary	Rotary	Rotary	
	Refrigerant type		R410A	R410A	R410A	R410A	R410A	R410A	
Working temp.	Refrigerant liquid pipe	mm	9.52	9.52	9.52	9.52	9.52	9.52	
	Refrigerant gas pipe	mm	19.05	19.05	19.05	19.05	19.05	19.05	
	Max pipe length	m	50	50	50	50	50	50	
Working temp.	Max drop between U.S.O.U	m	30	30	30	30	30	30	
	Cooling (Min-Max)	°C	-10~46	-10~46	-10~46	-10~46	-10~46	-10~46	
	Heating (Min-Max)	°C	-15~24	-15~24	-15~24	-15~24	-15~24	-15~24	

\* Model is under development, data is for reference.

Controller & BMS	Design	Model	Functions	For what units
Touch screen central controller		YCZ-A003	*Central control, max. 128 group units *Weekly timer *Zone control	Cassette Convertible Duct type Cabinet
*Connect with YCJ-A002 to realize central control				
Wired controller		YR-E16	*Single unit control *Group control, max. 16 units *Weekly timer *Clock *Mode: cooling, heating, auto, air flow, dehumidification *Temperature, fan speed, fan direction	Cassette Convertible Duct type Cabinet
Wired controller		YR-E14	*Single unit control *Group control, max. 16 units *Clock *Timer *Mode: cooling, heating, auto, air flow, dehumidification *Temperature, fan speed, fan direction	Cassette Convertible Duct type Cabinet
Infrared controller		YR-HD	*Single unit operation *Cool, heat, dry, quiet separated button *Clock *Timer *Mode: cooling, heating, auto, air flow, dehumidification	All
Wireless control receiver		RE-02	Realize infrared control for duct type	Duct

<b>Models Line-up</b>	<b>101</b>
<b>Benefits</b>	<b>103</b>
Cassette	<b>105</b>
Convertible	<b>109</b>
Low ESP Duct	<b>112</b>
Medium ESP Duct	<b>113</b>
High ESP Duct	<b>116</b>
Cabinet	<b>119</b>



# LIGHT COMMERCIAL ON/OFF

# Model Line-up



Btu/h	12000	18000	24000	28000	36000	36000	42000	48000	48000	48000	60000	60000	84000
kW	3.6	5.2	7.0	8.2	10.5	10.5	12.5	12.5	14.0	14.0	16.0	16.0	25.0
Universal outdoor unit	AU122AEEAA 	AU182AEEAA 	AU242AGEAA 	AU282AHEAA AU28NAHEAA 	AU362ALEAA 	AU362AIEAA AU36NAIEAA 	AU42NALEAA 	1U48LS1EAB 	1U48RS1EAB 	AU48NAIEAA 	1U60KS1EAB 	AU60NAIEAA 	AU84NATEAA 
Cassette type	AB122ACEAA 	AB182ACEAA 	AB242AEEAA 	AB282AEEAA 	AB362ACEAA 	AB422AEEAA 	AB48S1ERA 	AB48S1ERA 	AB482ACEAA 	AB60CS1ERA 	AB602ACEAA 		
Convertible type	AC122ACEAA 	AC182ACEAA 	AC242ACEAA 	AC282AFEAA 	AC362AFEAA 		AC48FS1ERA 	AC48FS1ERA 	AC482AFEAA 	AC60FS1ERA 	AC602AFEAA 		
Low ESP duct type 25Pa	AD122ALEAA 	AD182ALEAA 	AD242ALEAA 										
Medium ESP duct type 50/100Pa		AD182AMEAA 	AD242AMEAA 	AD282AMEAA 	AD362ANEAA 	AD362AMEAA 	AD422ANEAA 	AD48NS1ERA 	AD48NS1ERA 	AD482AMEAA 			
High ESP duct type 150Pa				AD282AHEAA 		AD362AHEAA 		AD48HS1ERA 	AD48HS1ERA 	AD482AHEAA 	AD60HS1ERA 	AD602AHEAA 	AD842AHEAA 
Cabinet type							AP422ACEAA 	AP48DS1ERA AP48KS1ERA 	AP48DS1ERA AP48KS1ERA 	AP482AKEAA 	AP60KS1ERA 		

• Design, specifications and model pictures are subject to change without prior notice for product improvement.

# Benefits



SERIES	MODEL	INTELLIGENT & COMFORT										HEALTH			CONVENIENT				DESIGN				ENERGY SAVING			
		Auto mode	Power mode	On-Off card	Group control	Central control	Comfortable sleep	Left & right airflow	3D comfortable airflow	Quiet operation	Auto-swing	4-way airflow	Fresh air	Auto restart	3 min protection	Weekly timer	24 hours timer	Super match	Compact design	Easy clean design	2 ways drain piping connection	Low ambient cooling	Drain water pump	LED display	LCD display	High performance compressor
Cassette type	AB122ACEAA	✓		✓			✓					✓	✓	✓	✓			✓				✓			✓	
	AB182ACEAA	✓		✓			✓					✓	✓	✓	✓			✓				✓			✓	
	AB242AEEAA	✓		✓			✓					✓	✓	✓	✓			✓				✓			✓	
	AB282AEEAA	✓		✓			✓					✓	✓	✓	✓			✓				✓			✓	
	AB362ACEAA	✓		✓			✓					✓	✓	✓	✓			✓				✓			✓	
	AB482ACEAA	✓		✓			✓					✓	✓	✓	✓			✓				✓			✓	
	AB48ES1ERA	✓	✓	✓			✓					✓	✓	✓	✓			✓				✓			✓	
Convertible type	AB60CS1ERA	✓	✓	✓			✓					✓	✓	✓	✓			✓				✓			✓	
	AB602ACEAA	✓		✓			✓					✓	✓	✓	✓			✓				✓			✓	
	AC122ACEAA	✓		✓			✓					✓	✓	✓	✓			✓				✓			✓	
	AC182ACEAA	✓		✓			✓					✓	✓	✓	✓			✓				✓			✓	
	AC242ACEAA	✓		✓			✓					✓	✓	✓	✓			✓				✓			✓	
	AC282AFEAA	✓		✓			✓				✓	✓	✓	✓	✓			✓				✓			✓	
	AC362AFEAA	✓		✓			✓				✓	✓	✓	✓	✓			✓				✓			✓	
Low ESP duct type	AC48FS1ERA	✓	✓	✓			✓					✓	✓	✓	✓			✓				✓			✓	
	AC482AFEAA	✓		✓			✓					✓	✓	✓	✓			✓				✓			✓	
	AC60FS1ERA	✓	✓	✓			✓					✓	✓	✓	✓			✓				✓			✓	
	AC602AFEAA	✓		✓			✓				✓	✓	✓	✓	✓			✓				✓			✓	
	AD122ALEAA	✓		✓			✓						✓	✓	✓	✓			✓				✓			✓
	AD182ALEAA	✓		✓			✓						✓	✓	✓	✓			✓				✓			✓
	AD242ALEAA	✓		✓			✓						✓	✓	✓	✓			✓				✓			✓
Medium ESP duct type	AD182AMEAA	✓		✓			✓						✓	✓	✓	✓			✓			✓			✓	
	AD242AMEAA	✓		✓			✓						✓	✓	✓	✓			✓				✓			✓
	AD282AMEAA	✓		✓			✓						✓	✓	✓	✓			✓				✓			✓
	AD362ANEAA	✓		✓			✓						✓	✓	✓	✓			✓				✓			✓
	AD362AMEAA	✓		✓			✓						✓	✓	✓	✓			✓				✓			✓
	AD422ANEAA	✓		✓			✓						✓	✓	✓	✓			✓				✓			✓
	AD48NS1ERA	✓	✓	✓			✓			✓			✓	✓	✓	✓			✓				✓			✓
High ESP duct type	AD482AMEAA	✓		✓			✓						✓	✓	✓	✓			✓			✓			✓	
	AD282AHEAA	✓		✓			✓						✓	✓	✓	✓			✓				✓			✓
	AD362AHEAA	✓		✓			✓						✓	✓	✓	✓			✓				✓			✓
	AD48HS1ERA	✓	✓	✓			✓						✓	✓	✓	✓			✓				✓			✓
	AD482AHEAA	✓		✓			✓						✓	✓	✓	✓			✓				✓			✓
	AD60HS1ERA	✓	✓	✓			✓			✓			✓	✓	✓	✓			✓				✓			✓
	AD602AHEAA	✓		✓			✓						✓	✓	✓	✓			✓				✓			✓
Cabinet type	AD842AHEAA	✓		✓			✓						✓	✓	✓	✓			✓				✓			✓
	AP422ACEAA	✓		✓			✓						✓	✓	✓	✓			✓				✓			✓
	AP48DS1ERA	✓	✓	✓			✓			✓			✓	✓	✓	✓			✓	✓			✓			✓
	AP48KS1ERA	✓	✓	✓			✓			✓			✓	✓	✓	✓			✓				✓		✓	✓
	AP482AKEAA	✓		✓			✓						✓	✓	✓	✓			✓				✓		✓	✓
AP60KS1ERA	✓	✓	✓			✓			✓			✓	✓	✓	✓			✓				✓		✓	✓	

✓: Standard    ✓: Optional

# CASSETTE TYPE



- AB122ACEAA
- AB182ACEAA
- AB242AEEAA



Model/Indoor unit			AB122ACEAA	AB182ACEAA	AB242AEEAA	
Capacity	Cooling	Btu/h	14000	15700	24000	
		kW	4.1	4.6	7.25	
Capacity	Heating	Btu/h	15700	16700	25000	
		kW	4.6	4.9	7.4	
Electrical	Power supply	Ph/V/Hz	1/230/50	1/230/50	1/230/50	
Performance	Air flow (H/M/L)	m <sup>3</sup> /h	700/620/520	700/640/480	1300/1100/870	
	Noise level (H/M/L)	dB(A)	45/40/32	45/42/40	48/44/39	
	External dimensions (W/D/H)	mm	570/570/260	570/570/260	840/840/240	
	Shipping dimensions (W/D/H)	mm	718/680/380	718/680/380	930/930/330	
Installation	Net/Shipping weight	kg	19/23.5	19/23.5	26.8/32.6	
	Refrigerant liquid pipe	mm	6.35	6.35	9.52	
	Refrigerant gas pipe	mm	12.7	12.7	15.88	
	Max pipe length	mm	15	20	30	
	Max drop between IN&OU	m	5	10	15	
Controller	Wired(O-optional, S-standard)		YR-E14(O)	YR-E14(O)	YR-E14(O)	
	Infrared(O-optional, S-standard)		YR-H71(S)	YR-H71(S)	YR-H71(S)	
Panel	Model		PB-700JA	PB-700JA	PB-950JA	
	External dimensions (W/D/H)	mm	700/700/60	700/700/60	950/950/60	
	Shipping dimensions (W/D/H)	mm	740/750/115	740/750/115	985/985/115	
	Net/Shipping weight	kg	3.5/4.5	3.5/4.5	6/9	
Model/Outdoor unit			AU122AEEAA	AU182AEEAA	AU242AGEAA	
Electrical parameters	Power supply	Ph/V/Hz	1/230/50	1/230/50	1/230/50	
	Power input	Cooling	kW	1.34	1.65	2.40
		Heating	kW	1.27	1.60	2.30
	EER/COP		3.06/3.62	2.79/3.06	3.02/3.22	
Performance	Energy class		B/A	D/D	B/C	
	Air flow (H)	m <sup>3</sup> /h	2300	2500	3000	
Installation	Noise level (H)	dB(A)	55	55	56	
	External dimensions (W/D/H)	mm	780/245/640	780/245/640	860/308/730	
	Shipping dimensions (W/D/H)	mm	930/340/714	930/340/714	995/420/815	
	Net/Shipping weight	kg	41/43	41/43	57/60.5	
Working temp.	Compressor type (Scroll/Rotary)		Rotary	Rotary	Rotary	
	Cooling Normal	°C	10-43	10-43	10-43	
	Adopting fan speed controller	°C	-15-43	-15-43	-15-43	
	Heating	°C	-7-24	-7-24	-7-24	

\* Model is under development, data is for reference.

- AB282AEEAA
- AB362AEEAA



Model/Indoor unit			AB282AEEAA	AB282AEEAA	AB362AEEAA	AB362AEEAA	
Capacity	Cooling	Btu/h	28000	28000	36000	39200	
		kW	8.2	8.2	10	11.5	
Capacity	Heating	Btu/h	30000	30000	41000	41100	
		kW	8.8	8.4	10.5	12.0	
Electrical	Power supply	Ph/V/Hz	1/230/50	1/230/50	1/230/50	1/230/50	
Performance	Air flow (H/M/L)	m <sup>3</sup> /h	1300/1100/870	1300/1100/870	1600/1450/1300	1600/1450/1300	
	Noise level (H/M/L)	dB(A)	48/44/39	48/44/39	47/42/37	47/42/37	
	External dimensions (W/D/H)	mm	840/840/240	840/840/240	840/840/290	840/840/290	
	Shipping dimensions (W/D/H)	mm	930/930/330	930/930/330	930/930/390	930/930/390	
Installation	Net/Shipping weight	kg	26.8/32.6	26.8/32.6	38/45	38/45	
	Refrigerant liquid pipe	mm	9.52	9.52	9.52	9.52	
	Refrigerant gas pipe	mm	15.88	15.88	19.05	19.05	
	Max pipe length	mm	30	30	50	50	
	Max drop between IN&OU	m	15	15	30	30	
Controller	Wired(O-optional, S-standard)		YR-E14(O)	YR-E14(O)	YR-E14(O)	YR-E14(O)	
	Infrared(O-optional, S-standard)		YR-H71(S)	YR-H71(S)	YR-H71(S)	YR-H71(S)	
Panel	Model		PB-950JA	PB-950JA	PB-950JA	PB-950JA	
	External dimensions (W/D/H)	mm	950/950/60	950/950/60	950/950/60	950/950/60	
	Shipping dimensions (W/D/H)	mm	985/985/115	985/985/115	985/985/115	985/985/115	
	Net/Shipping weight	kg	6/9	6/9	6/9	6/9	
Model/Outdoor unit			AU282AEEAA	AU282AEEAA	AU362AEEAA	AU362AEEAA	
Electrical parameters	Power supply	Ph/V/Hz	1/230/50	3/400/50	1/230/50	3/400/50	
	Power input	Cooling	kW	2.7	3.3	3.8	3.8
		Heating	kW	2.74	2.6	3.5	3.9
	EER/COP		3.04/3.21	2.93/3.23	3.03/3	3.03/3.08	
Performance	Energy class		B/C	C/C	B/D	B/D	
	Air flow (H)	m <sup>3</sup> /h	4000	4000	7000	7000	
Installation	Noise level (H)	dB(A)	58	58	60	60	
	External dimensions (W/D/H)	mm	948/340/840	948/340/840	948/340/1250	948/340/1250	
	Shipping dimensions (W/D/H)	mm	1095/410/935	1095/410/935	1095/410/1400	1095/410/1400	
	Net/Shipping weight	kg	74/89	74/89	96/101	103/108	
Working temp.	Compressor type (Scroll/Rotary)		Rotary	Rotary	Rotary	Scroll	
	Cooling Normal	°C	10-43	10-43	10-43	10-43	
	Adopting fan speed controller	°C	-15-43	-15-43	-15-43	-15-43	
	Heating	°C	-7-24	-7-24	-7-24	-7-24	

\* Model is under development, data is for reference.

# CASSETTE TYPE



- AB422AEEAA
- AB48ES1ERA



42K



48K



42K



1U48LS1EAB



1U48IS1EAB

- Auto mode
- Power mode
- On-Off card
- Group controller
- Central control
- Comfortable sleep
- Auto-swing
- 4-way airflow
- Fresh air
- Auto restart
- 3 minutes protection
- Weekly timer
- 24 hours timer
- Super match
- Drain water pump
- High performance compressor

- AB482ACEAA
- AB60CS1ERA
- AB602ACEAA



48.60K



48.60K

- Auto mode
- Power mode
- On-Off card
- Group controller
- Central control
- Comfortable sleep
- Auto-swing
- 4-way airflow
- Fresh air
- Auto restart
- 3 minutes protection
- Weekly timer
- 24 hours timer
- Super match
- Drain water pump
- High performance compressor

Model/Indoor unit			AB422AEEAA	AB48ES1ERA	AB48ES1ERA *
Capacity	Cooling	Btu/h	42000	44700	48100
	Heating	Btu/h	45000	48100	52900
Electrical	Power supply	Ph/V/Hz	1/230/50	1/230/50/60	1/230/50/60
	Air flow (H/M/L)	m <sup>3</sup> /h	1600/-/-	1600/1450/1300	1600/1450/1300
Performance	Noise level (H/M/L)	dB(A)	47/42/37	50/48/46	50/48/46
	External dimensions (W/D/H)	mm	840/840/290	840/840/290	840/840/290
Installation	Shipping dimensions (W/D/H)	mm	930/930/390	930/930/390	930/930/390
	Net/Shipping weight	kg	38/45	38/45	38/45
	Refrigerant liquid pipe	mm	9.52	9.52	9.52
	Refrigerant gas pipe	mm	19.05	19.05	19.05
	Max pipe length	mm	50	50	50
	Max drop between IN&OU	m	30	30	30
	Controller	Wired(O-optional, S-standard)		YR-E14(O)	YR-E14(O)
Panel	Infrared(O-optional, S-standard)		YR-H71(S)	YR-HD(S)	YR-HD(S)
	Model		PB-950JA	PB-950JB	PB-950JB
	External dimensions (W/D/H)	mm	950/950/60	950/950/60	950/950/60
	Shipping dimensions (W/D/H)	mm	985/985/115	985/985/115	985/985/115
	Net/Shipping weight	kg	6/9	4.2/6.3	4.2/6.3
Model/Outdoor unit			AU42NALEAA	1U48LS1EAB	1U48IS1EAB *
Electrical parameters	Power supply	Ph/V/Hz	3/400/50	3/400/50	3/400/50
	Power input	kW	4.71	4.34	4.66
	Heating	kW	5.35	4.64	4.82
Performance	EER/COP		2.61/2.47	2.84/3.21	3.03/3.22
	Energy class	D/F		C/C	B/C
Performance	Air flow (H)	m <sup>3</sup> /h	5500	4200	6500
	Noise level (H)	dB(A)	59	60	58
Installation	External dimensions (W/D/H)	mm	1008/410/830	1008/410/830	948/340/1250
	Shipping dimensions (W/D/H)	mm	1130/490/930	1130/490/930	1095/410/1400
	Net/Shipping weight	kg	91/102	80/90	108/118
	Compressor type (Scroll/Rotary)		Scroll	Rotary	SCROOL
Working temp.	Cooling Normal	°C	10-43	10-43	10-46
	Adopting fan speed controller	°C	-15-43	-10-43	/
	Heating	°C	-7-24	-7-24	-7-24

\* Model is under development, data is for reference.

Model/Indoor unit			AB482ACEAA	AB60CS1ERA *	AB602ACEAA
Capacity	Cooling	Btu/h	46400	51500	51500
	Heating	Btu/h	54600	58300	58000
Electrical	Power supply	Ph/V/Hz	1/230/50	1/230/50	1/230/50
	Air flow (H/M/L)	m <sup>3</sup> /h	1750/-/-	1980/1750/1500	1980/-/-
Performance	Noise level (H/M/L)	dB(A)	51/49/44	49/44/42	51/47/43
	External dimensions (W/D/H)	mm	600/350/1850	1230/840/280	1230/840/280
Installation	Shipping dimensions (W/D/H)	mm	660/420/1980	1325/920/370	1325/920/370
	Net/Shipping weight	kg	59/70	46/53	46/53
	Refrigerant liquid pipe	mm	9.52	9.52	9.52
	Refrigerant gas pipe	mm	19.05	19.05	19.05
	Max pipe length	mm	50	50	50
	Max drop between IN&OU	m	30	30	30
	Controller	Wired(O-optional, S-standard)		/	YR-E14(O)
Panel	Infrared(O-optional, S-standard)		YR-H49(S)	YR-HD(S)	YR-H71(S)
	Model		PB-1340IA	PB-1340IB	PB-1340IA
	External dimensions (W/D/H)	mm	1340/950/80	1340/950/80	1340/950/80
	Shipping dimensions (W/D/H)	mm	1400/995/115	1400/995/115	1400/995/115
	Net/Shipping weight	kg	8.4/12	8.4/12	8.4/12
Model/Outdoor unit			AU48NAIEAA	1U60IS1EAB *	AU60NAIEAA
Electrical parameters	Power supply	Ph/V/Hz	3/400/50	3/400/50	3/400/50
	Power input	kW	4.5	5.0	5.0
	Heating	kW	5.25	5.3	5.3
Performance	EER/COP		3.02/3.05	3.02/3.23	3.02/3.23
	Energy class	B/D		B/C	B/C
Performance	Air flow (H)	m <sup>3</sup> /h	8000	6500	8000
	Noise level (H)	dB(A)	60	58	60
Installation	External dimensions (W/D/H)	mm	948/340/1250	948/340/1250	948/340/1250
	Shipping dimensions (W/D/H)	mm	1095/410/1400	1095/410/1400	1095/410/1400
	Net/Shipping weight	kg	106/111	108/118	106/111
	Compressor type (Scroll/Rotary)		Scroll	SCROOL	Scroll
Working temp.	Cooling Normal	°C	10-43	10-46	10-43
	Adopting fan speed controller	°C	-15-43	/	-15-43
	Heating	°C	-7-24	-7-24	-7-24

\* Model is under development, data is for reference.

# CONVERTIBLE TYPE



- AC122ACEAA
- AC182ACEAA
- AC242ACEAA

- AC282AFEAA
- AC362AFEAA



Model/Indoor unit			AC122ACEAA	AC182ACEAA	AC242ACEAA	
Capacity	Cooling	Btu/h	14300	17500	23200	
		kW	4.2	5.1	6.8	
Heating	Btu/h	15900	18600	25600		
	kW	4.6	5.45	7.4		
Electrical	Power supply	PhV/Hz	1/230/50	1/230/50	1/230/50	
	Air flow (H/M/L)	m <sup>3</sup> /h	750/650/550	750/650/550	750/650/550	
Performance	Noise level (H/M/L)	dB(A)	46/44/42	48/46/44	48/46/44	
	External dimensions (W/D/H)	mm	990/655/199	990/655/199	990/655/199	
	Shipping dimensions (W/D/H)	mm	1150/750/300	1150/750/300	1150/750/300	
	Net/Shipping weight	kg	28.3/34.3	28.3/34.3	28.3/34.3	
	Refrigerant liquid pipe	mm	6.35	6.35	9.52	
Installation	Refrigerant gas pipe	mm	12.7	12.7	15.88	
	Max pipe length	mm	15	20	30	
	Max drop between I.N.&O.U	m	5	10	15	
	Controller	Wired(O-optional, S-standard) Infrared(O-optional, S-standard)		YR-E14(O) YR-H71(S)	YR-E14(O) YR-H71(S)	YR-E14(O) YR-H71(S)
Model/Outdoor unit			AU122AEEAA	AU182AEEAA	AU242AGEAA	
Electrical parameters	Power supply	PhV/Hz	1/230/50	1/230/50	1/230/50	
	Power input	Cooling	kW	1.5	1.69	2.4
		Heating	kW	1.27	1.65	2.45
Performance	EER/COP		3.23/3.62	3.02/3.30	2.83/3.02	
	Energy class		A/A	B/C	C/D	
Performance	Air flow (H)	m <sup>3</sup> /h	2300	2300	3000	
	Noise level (H)	dB(A)	55	55	56	
Installation	External dimensions (W/D/H)	mm	780/245/640	780/245/640	860/308/730	
	Shipping dimensions (W/D/H)	mm	930/340/714	930/340/714	995/420/815	
	Net/Shipping weight	kg	41/43	41/43	57/60.5	
	Compressor type (Scroll/Rotary)		Rotary	Rotary	Rotary	
Working temp.	Cooling Normal	°C	10-43	10-43	10-43	
	Adopting fan speed controller	°C	-15-43	-15-43	-15-43	
	Heating	°C	-7-24	-7-24	-7-24	

\* Model is under development, data is for reference.



Model/Indoor unit			AC282AFEAA	AC282AFEAA	AC362AFEAA	AC362AFEAA	
Capacity	Cooling	Btu/h	28000	29300	36000	36000	
		kW	8.6	8.6	11	11.5	
Heating	Btu/h	32500	31300	40000	40000		
	kW	9.5	9.2	12	13		
Electrical	Power supply	PhV/Hz	1/230/50	1/230/50	1/230/50	1/230/50	
	Air flow (H/M/L)	m <sup>3</sup> /h	1550/1300/1000	1550/1300/1000	1800/1600/1400	1800/1600/1400	
Performance	Noise level (H/M/L)	dB(A)	50/48/46	50/48/46	51/49/47	51/49/47	
	External dimensions (W/D/H)	mm	1580/700/240	1580/700/240	1580/700/240	1580/700/240	
	Shipping dimensions (W/D/H)	mm	1710/790/315	1710/790/315	1710/790/315	1710/790/315	
	Net/Shipping weight	kg	50/57	50/57	54/61	54/61	
	Refrigerant liquid pipe	mm	9.52	9.52	9.52	9.52	
Installation	Refrigerant gas pipe	mm	15.88	15.88	19.05	19.05	
	Max pipe length	mm	30	30	50	50	
	Max drop between I.N.&O.U	m	15	15	30	30	
	Controller	Wired(O-optional, S-standard) Infrared(O-optional, S-standard)		YR-E14(O) YR-H50(S)	YR-E14(O) YR-H50(S)	YR-E14(O) YR-H50(S)	
Model/Outdoor unit			AU282AHEAA	AU28NAHEAA	AU362AIEAA	AU36NAIEAA	
Electrical parameters	Power supply	PhV/Hz	1/230/50	3/400/50	1/230/50	3/400/50	
	Power input	Cooling	kW	2.68	2.8	3.4	3.9
		Heating	kW	2.63	2.5	3.5	3.9
Performance	EER/COP		3.21/3.61	3.09/3.68	3.24/3.43	2.95/3.33	
	Energy class		A/A	B/A	A/B	C/C	
Performance	Air flow (H)	m <sup>3</sup> /h	4000	4000	7000	7000	
	Noise level (H)	dB(A)	58	58	60	60	
Installation	External dimensions (W/D/H)	mm	948/340/840	948/340/840	948/340/1250	948/340/1250	
	Shipping dimensions (W/D/H)	mm	1095/410/935	1095/410/935	1095/410/1400	1095/410/1400	
	Net/Shipping weight	kg	74/89	74/89	96/101	103/108	
	Compressor type (Scroll/Rotary)		Rotary	Rotary	Rotary	Scroll	
Working temp.	Cooling Normal	°C	10-43	10-43	10-43	10-43	
	Adopting fan speed controller	°C	-15-43	-15-43	-15-43	-15-43	
	Heating	°C	-7-24	-7-24	-7-24	-7-24	

\* Model is under development, data is for reference.

# CONVERTIBLE TYPE

# Low ESP DUCT



- AC48FS1ERA
- AC482AFEAA
- AC60FS1ERA
- AC602AFEAA

- AD122ALEAA
- AD182ALEAA
- AD242ALEAA



Model/Indoor unit		AC48FS1ERA	AC48FS1ERA*	AC482AFEAA	AC60FS1ERA*	AC602AFEAA	
Capacity	Cooling	Btu/h 47700	49500	48000	53200	55000	
	Heating	kW 13	14.5	14.06	15.5	16.1	
Electrical	Power supply	Btu/h 54600	52850	56300	57330	62100	
		kW 14	15.5	17	16.8	18.2	
Performance	Power supply	PhV/Hz	1/230/50/60	1/230/50/60	1/230/50	1/230/50/60	
	Air flow (H/M/L)	m³/h	2000/1800/1400	2000/1800/1400	2000/1800/1400	2000/1800/1400	
	Noise level (H/M/L)	dB(A)	53/51/49	53/51/49	53/51/49	53/51/49	
	External dimensions (W/D/H)	mm	1580/700/240	1580/700/240	1580/700/240	1580/700/240	
	Shipping dimensions (W/D/H)	mm	1710/790/315	1710/790/315	1710/790/315	1710/790/315	
	Net/Shipping weight	kg	54/61	54/61	54/61	54/61	
Installation	Refrigerant liquid pipe	mm	9.52	9.52	9.52	9.52	
	Refrigerant gas pipe	mm	19.05	19.05	19.05	19.05	
	Max pipe length	mm	50	50	50	50	
	Max drop between I.N.&O.U	m	50	50	50	50	
Controller	Wired(O-optional, S-standard)		YR-E14(O)	YR-E14(O)	YR-E14(O)	YR-E14(O)	
	Infrared(O-optional, S-standard)		YR-HD(S)	YR-HD(S)	YR-HD(S)	YR-HD(S)	
Model/Outdoor unit		1U48LS1EAB	1U48IS1EAB*	AU48NAIEAA	1U60IS1EAB*	AU60NAIEAA	
Electrical parameters	Power supply	PhV/Hz	3/400/50	3/400/50	3/400/50	3/400/50	
	Power input (Cooling)	kW	4.31	4.51	4.6	5.13	5.2
	(Heating)	kW	4.09	4.28	4.95	5.23	5.34
Performance	EER/COP		3.01/3.42	3.22/3.62	3.06/3.45	3.02/3.21	3.1/3.41
	Energy class		B/B	A/A	B/B	B/B	B/B
Performance	Air flow (H)	m³/h	4200	6500	8000	7000	8000
	Noise level (H)	dB(A)	60	58	60	58	60
Installation	External dimensions (W/D/H)	mm	1008/447/830	948/340/1250	948/340/1250	948/340/1250	948/340/1250
	Shipping dimensions (W/D/H)	mm	1130/490/930	1095/410/1400	1095/410/1400	1095/410/1400	1095/410/1400
	Net/Shipping weight	kg	95/105	108/118	106/111	108/118	106/111
	Compressor type (Scroll/Rotary)		Rotary	SCROOL	Scroll	SCROOL	Scroll
Working temp.	Cooling Normal	°C	10-43	10-46	10-43	10-46	10-43
	Adopting fan speed controller	°C	-10-43	/	-15-43	/	-15-43
	Heating	°C	-7-24	-7-24	-7-24	-7-24	-7-24

\* Model is under development, data is for reference

Model/Indoor unit		AD122ALEAA	AD182ALEAA	AD242ALEAA	
Capacity	Cooling	Btu/h 13000	16400	24000	
	Heating	kW 3.8	4.8	7.25	
Electrical	Power supply	Btu/h 14000	17000	26000	
		kW 4.1	5	7.6	
Performance	Power supply	PhV/Hz	1/230/50	1/230/50	1/230/50
	Air flow (H/M/L)	m³/h	550/500/400	780/700/600	1200/1050/850
	Noise level (H/M/L)	dB(A)	43/40/35	46/44/38	49/45/41
	External dimensions (W/D/H)	mm	610/484/220	1090/484/220	1090/484/220
	Shipping dimensions (W/D/H)	mm	710/545/280	1174/545/280	1174/545/280
	Net/Shipping weight	kg	14/16	23/26.5	25.2/28.4
Installation	Static pressure	Pa	25	25	25
	Refrigerant liquid pipe	mm	6.35	6.35	9.52
	Refrigerant gas pipe	mm	9.52	12.7	15.88
	Max pipe length	mm	15	20	30
Controller	Wired(O-optional, S-standard)		YR-E14(S)	YR-E14(O)	YR-E14(S)
	Infrared(O-optional, S-standard)		YR-H7(S)	YR-H7(S)	YR-H7(S)
Model/Outdoor unit		AU122AEAAA	AU182AEAAA	AU242AGEAA	
Electrical parameters	Power supply	PhV/Hz	1/230/50	1/230/50	1/230/50
	Power input (Cooling)	kW	1.3	1.70	2.40
	(Heating)	kW	1.35	1.60	2.30
Performance	EER/COP		2.92/3.04	2.82/3.12	3.02/3.30
	Energy class		C/D	C/D	B/C
Performance	Air flow (H)	m³/h	2300	2300	3000
	Noise level (H)	dB(A)	55	55	56
Installation	External dimensions (W/D/H)	mm	780/245/640	780/245/640	865/308/730
	Shipping dimensions (W/D/H)	mm	930/340/714	930/340/714	995/420/815
	Net/Shipping weight	kg	41/43	41/43	57/60.5
	Compressor type (Scroll/Rotary)		Rotary	Rotary	Rotary
Working temp.	Cooling Normal	°C	10-43	10-43	10-43
	Adopting fan speed controller	°C	-15-43	-15-43	-15-43
	Heating	°C	-7-24	-7-24	-7-24

# Medium ESP DUCT



AD182AMEAA AD282AMEAA  
AD242AMEAA AD362AMEAA

AD362ANEAA  
AD422ANEAA



Model/Indoor unit			AD182AMEAA	AD242AMEAA	AD282AMEAA	AD282AMEAA	AD362AMEAA	AD362AMEAA
Capacity	Cooling	Btu/h	18000	24000	28000	28000	36000	36000
		kW	5.3	7.25	8.5	8.5	10.5	11
	Heating	Btu/h	20000	26000	31000	30700	37500	42000
		kW	5.8	7.6	9.1	9.0	11	12.5
Electrical	Power supply	Ph/V/Hz	1/230/50	1/230/50	1/230/50	1/230/50	1/230/50	1/230/50
	Air flow (H/M/L)	m <sup>3</sup> /h	1200/1050/850	1470/1300/1100	1470/1300/1100	1470/1300/1100	1500/1300/1100	1500/1300/1100
Performance	Noise level (H/M/L)	dB(A)	45/42/40	47/43/41	47/43/41	47/43/41	47/45/43	47/45/43
	External dimensions (W/D/H)	mm	990/650/300	990/650/300	990/650/300	990/650/300	990/650/300	990/650/300
	Shipping dimensions (W/D/H)	mm	1167/860/345	1167/860/345	1167/860/345	1167/860/345	1167/860/345	1167/860/345
	Net/Shipping weight	kg	39/45	40/46.4	40/46.4	40/46.4	40/46.4	40/46.4
	Static pressure	Pa	50	50	50	50	50	50
	Installation	Refrigerant liquid pipe	mm	6.35	9.52	9.52	9.52	9.52
	Refrigerant gas pipe	mm	12.7	15.88	15.88	15.88	19.05	19.05
	Max pipe length	m	20	30	30	30	50	50
Controller	Wired(O-optional, S-standard)		YR-E14(S)	YR-E14(S)	YR-E14(S)	YR-E14(S)	YR-E14(S)	YR-E14(S)
	Infrared(O-optional, S-standard)		YR-H71(O)	YR-H71(O)	YR-H71(O)	YR-H71(O)	YR-H71(O)	YR-H71(O)
Model/Outdoor unit			AU182AEAA	AU242GEAA	AU282AEAA	AU282AEAA	AU362AEAA	AU362AEAA
Electrical parameters	Power supply	Ph/V/Hz	1/230/50	1/230/50	1/230/50	3/400/50	1/230/50	3/400/50
	Power input	Cooling	kW	1.89	2.40	2.82	2.8	3.65
		Heating	kW	1.70	2.30	2.8	2.65	3.7
		EER/COP		2.81/3.41	3.02/3.30	3.01/3.25	3.04/3.4	3.09/2.97
	Energy class		C/B	B/C	B/C	B/D	B/D	
Performance	Air flow (H)	m <sup>3</sup> /h	2500	3000	4000	4000	7000	7000
	Noise level (H)	dB(A)	55	56	58	58	60	60
Installation	External dimensions (W/D/H)	mm	780/245/640	865/308/730	948/340/840	948/340/840	948/340/1250	948/340/1250
	Shipping dimensions (W/D/H)	mm	930/340/714	995/420/815	1095/410/935	1095/410/935	1095/410/1400	1095/410/1400
	Net/Shipping weight	kg	41/43	57/60.5	74/89	74/89	96/101	103/108
	Compressor type (Scroll/Rotary)		Rotary	Rotary	Rotary	Rotary	Rotary	Scroll
Working temp.	Cooling Normal	°C	10-43	10-43	10-43	10-43	10-43	10-43
	Adopting fan speed controller	°C	-15-43	-15-43	-15-43	-15-43	-15-43	-15-43
	Heating	°C	-7-24	-7-24	-7-24	-7-24	-7-24	-7-24

Model/Indoor unit			AD362ANEAA	AD422ANEAA	
Capacity	Cooling	Btu/h	36000	42000	
		kW	10.5	12.3	
	Heating	Btu/h	41000	45000	
		kW	12	13.2	
Electrical	Power supply	Ph/V/Hz	1/230/50	1/230/50	
	Air flow (H/M/L)	m <sup>3</sup> /h	1700	1700	
Performance	Noise level (H/M/L)	dB(A)	51/49/47/43	51/49/47/43	
	External dimensions (W/D/H)	mm	1135/742/270	1135/742/270	
	Shipping dimensions (W/D/H)	mm	1300/850/380	1300/850/380	
	Net/Shipping weight	kg	52/55	52/55	
	Static pressure	Pa	80	80	
	Installation	Refrigerant liquid pipe	mm	9.52	9.52
	Refrigerant gas pipe	mm	19.05	19.05	
	Max pipe length	m	50	50	
Controller	Wired(O-optional, S-standard)		YR-E14(S)	YR-E14(S)	
	Infrared(O-optional, S-standard)		YR-H71(O)	YR-H71(O)	
Model/Outdoor unit			AU362ALEAA	AU422ALEAA	
Electrical parameters	Power supply	Ph/V/Hz	1/230/50	3/400/50	
	Power input	Cooling	kW	3.48	5.1
		Heating	kW	3.45	4.8
		EER/COP		3.02/3.48	2.41/2.75
	Energy class		B/B	E/E	
Performance	Air flow (H)	m <sup>3</sup> /h	5500	5500	
	Noise level (H)	dB(A)	59	59	
Installation	External dimensions (W/D/H)	mm	1008/410/830	1008/410/830	
	Shipping dimensions (W/D/H)	mm	1030/490/930	1030/490/930	
	Net/Shipping weight	kg	90/101	91/102	
	Compressor type (Scroll/Rotary)		Scroll	Scroll	
Working temp.	Cooling Normal	°C	10-43	10-43	
	Adopting fan speed controller	°C	-15-43	-15-43	
	Heating	°C	-7-24	-7-24	

# Medium ESP DUCT

# High ESP DUCT



- AD48NS1ERA
- AD482AMEAA

- AD282AHEAA
- AD362AHEAA



Model/Indoor unit		AD48NS1ERA *	AD48NS1ERA *	AD482AMEAA
Capacity	Cooling	Btu/h	46000	48100
		kW	13.5	14.1
	Heating	Btu/h	49100	51800
		kW	14.4	15.2
Electrical	Power supply	PhV/Hz	1/230/50/60	1/230/50/60
Performance	Air flow (H/M/L)	m <sup>3</sup> /h	2090/1970/1792	2090/1970/1792
	Noise level (H/M/L)	dB(A)	49/47/43	49/47/43
Installation	External dimensions (W/D/H)	mm	1135/742/270	1410/645/350
	Shipping dimensions (W/D/H)	mm	1300/850/380	1557/800/370
	Net/Shipping weight	kg	52/55	55/60
	Static pressure	Pa	50/100	50
	Refrigerant liquid pipe	mm	9.52	9.52
Controller	Refrigerant gas pipe	mm	19.05	19.05
	Max pipe length	mm	50	50
	Max drop between IN&OU	m	30	30
	Wired(O-optional, S-standard)	YR-E14(S)	YR-E14(S)	YR-E14(S)
	Infrared(O-optional, S-standard)	YR-HD(O)	YR-HD(O)	YR-H71(O)
Model/Outdoor unit		1U48LS1EAB *	1U48IS1EAB *	AU48NAIEAA
Electrical parameters	Power supply	PhV/Hz	3/400/50	3/400/50
	Power input	kW	4.47	4.66
	Cooling	kW	4.45	4.8
	Heating	kW	4.45	4.8
Performance	EER/COP		3.02/3.24	3.03/3.42
	Energy class	B/C	B/C	B/A
Installation	Air flow (H)	m <sup>3</sup> /h	4200	6500
	Noise level (H)	dB(A)	59	58
Working temp.	External dimensions (W/D/H)	mm	1008/447/830	948/340/1250
	Shipping dimensions (W/D/H)	mm	1130/490/930	1095/410/1400
	Net/Shipping weight	kg	95/105	108/118
	Compressor type (Scroll/Rotary)		SCROOL	SCROOL
	Cooling Normal	°C	10-46	10-43
	Adopting fan speed controller	°C	/	-15-43
	Heating	°C	-7-24	-7-24

\* Model is under development, data is for reference

Model/Indoor unit		AD282AHEAA	AD282AHEAA	AD362AHEAA	AD362AHEAA
Capacity	Cooling	Btu/h	29000	27500	36000
		kW	8.5	8	10
	Heating	Btu/h	31000	29000	41000
		kW	9.1	8.5	11
Electrical	Power supply	PhV/Hz	1/230/50	1/230/50	1/230/50
Performance	Air flow (H/M/L)	m <sup>3</sup> /h	1470/1300/1000	1470/1300/1000	1500/1350/1200
	Noise level (H/M/L)	dB(A)	53/51/49	53/51/49	50/46/42
Installation	External dimensions (W/D/H)	mm	970/875/360	970/875/360	970/875/360
	Shipping dimensions (W/D/H)	mm	1051/940/510	1051/940/510	1051/940/510
	Net/Shipping weight	kg	48/58	48/58	48/58
	Static pressure	Pa	100	100	100
	Refrigerant liquid pipe	mm	9.52	9.52	9.52
Controller	Refrigerant gas pipe	mm	15.88	15.88	19.05
	Max pipe length	mm	30	30	50
	Max drop between IN&OU	m	15	15	30
	Wired(O-optional, S-standard)	YR-E14(S)	YR-E14(S)	YR-E14(S)	
	Infrared(O-optional, S-standard)	YR-H71(O)	YR-H71(O)	YR-H71(O)	
Model/Outdoor unit		AU282AHEAA	AU282AHEAA	AU362AHEAA	AU362AHEAA
Electrical parameters	Power supply	PhV/Hz	1/230/50	3/400/50	1/230/50
	Power input	kW	2.95	2.95	3.55
	Cooling	kW	2.83	2.82	3.65
	Heating	kW	2.83	2.82	3.65
Performance	EER/COP		2.88/3.22	2.71/3.01	2.82/3.01
	Energy class	C/C	C/C	D/D	D/D
Installation	Air flow (H)	m <sup>3</sup> /h	4000	4000	7000
	Noise level (H)	dB(A)	58	58	60
Working temp.	External dimensions (W/D/H)	mm	948/340/840	948/340/840	948/340/1250
	Shipping dimensions (W/D/H)	mm	1095/410/935	1095/410/935	1095/410/1400
	Net/Shipping weight	kg	74/89	74/89	96/101
	Compressor type (Scroll/Rotary)		Rotary	Rotary	Scroll
	Cooling Normal	°C	10-43	10-43	10-43
	Adopting fan speed controller	°C	-15-43	-15-43	-15-43
	Heating	°C	-7-24	-7-24	-7-24

# High ESP DUCT



AD48HS1ERA  
AD482AHEAA

AD60HS1ERA  
AD602AHEAA  
AD842AHEAA



1U48LS1EAB



1U48IS1EAB  
AU48NAIEAA



60K



84K



60K



84K



Model/Indoor unit			AD48HS1ERA	AD48HS1ERA *	AD482AHEAA	
Capacity	Cooling	Btu/h	46000	48100	46070	
		kW	13.5	14.1	13.5	
	Heating	Btu/h	49100	52850	59700	
		kW	15	15.5	17.5	
Electrical	Power supply	PhV/Hz	1/230/50/60	1/230/50/60	1/230/50	
	Air flow (H/M/L)	m <sup>3</sup> /h	2580/2070/1560	2580/2070/1560	2580/2070/1560	
Performance	Noise level (H/M/L)	dB(A)	50/46/42	50/46/42	50/46/42	
	External dimensions (W/D/H)	mm	1197/830/360	1197/830/360	1197/830/360	
	Shipping dimensions (W/D/H)	mm	1430/940/420	1430/940/420	1430/940/420	
	Net/Shipping weight	kg	62/70	62/70	62/70	
	Static pressure	Pa	50-150	50-150	100	
	Installation	Refrigerant liquid pipe	mm	9.52	9.52	9.52
Refrigerant gas pipe		mm	19.05	19.05	19.05	
Max pipe length		mm	50	50	50	
Max drop between IN&O.U		m	30	30	30	
Controller	Wireless (optional, S-standard)		YR-E14(O)	YR-E14(O)	YR-E14(S)	
	Infrared (O-optional, S-standard)		YR-HD(S)	YR-HD(S)	YR-H71(O)	
Model/Outdoor unit			1U48LS1EAB	1U48IS1EAB *	AU48NAIEAA	
Electrical parameters	Power supply	PhV/Hz	3/400/50	3/400/50	3/400/50	
	Power input	Cooling	kW	4.47	4.6	4.6
		Heating	kW	4.15	4.27	4.7
	EER/COP		3.02/3.61	3.05/3.63	2.96/3.72	
Performance	Energy class		B/A	B/A	C/A	
	Air flow (H)	m <sup>3</sup> /h	4200	4200	8000	
Installation	Noise level (H)	dB(A)	58	59	60	
	External dimensions (W/D/H)	mm	948/340/1250	948/340/1250	948/340/1250	
	Shipping dimensions (W/D/H)	mm	1095/410/1400	1095/410/1400	1095/410/1400	
	Net/Shipping weight	kg	108/118	108/118	106/111	
Working temp.	Compressor type (Scroll/Rotary)		SCROLL	Scroll	Scroll	
	Cooling Normal	°C	10-46	10-46	10-43	
	Adapting fan speed controller	°C	/	/	-15-43	
Heating	°C	-15-24	-7-24	-7-24		

\* Model is under development, data is for reference.

Model/Indoor unit			AD60HS1ERA *	AD602AHEAA	AD842AHEAA	
Capacity	Cooling	Btu/h	54600	50000	81900	
		kW	16	14.6	24	
	Heating	Btu/h	58700	62500	85300	
		kW	17.2	18.3	25	
Electrical	Power supply	PhV/Hz	1/230/50/60	1/230/50	1/230/50	
	Air flow (H/M/L)	m <sup>3</sup> /h	2580/2070/1560	2580/2070/1560	4000/3000/2000	
Performance	Noise level (H/M/L)	dB(A)	50/46/42	50/46/42	60/-	
	External dimensions (W/D/H)	mm	1197/830/360	1197/830/360	1570/880/360	
	Shipping dimensions (W/D/H)	mm	1430/940/420	1430/940/420	1800/1000/525	
	Net/Shipping weight	kg	62/70	62/70	92/100	
	Static pressure	Pa	50-150	100	130	
	Installation	Refrigerant liquid pipe	mm	9.52	9.52	12.7
Refrigerant gas pipe		mm	19.05	19.05	25.4	
Max pipe length		mm	50	50	50	
Max drop between IN&O.U		m	30	30	30	
Controller	Wireless (optional, S-standard)		YR-E14(S)	YR-E14(S)	YR-E14(S)	
	Infrared (O-optional, S-standard)		YR-HD(O)	YR-H71(O)	YR-H71(O)	
Model/Outdoor unit			1U60IS1EAB *	AU60NAHEAA	AU84NAIEAA	
Electrical parameters	Power supply	PhV/Hz	3/400/50	3/400/50	3/400/50	
	Power input	Cooling	kW	5.29	5	7.4
		Heating	kW	4.76	5	6.8
	EER/COP		3.02/3.61	2.82/3.66	3.24/3.68	
Performance	Energy class		C/A	C/A	A/A	
	Air flow (H)	m <sup>3</sup> /h	6500	8000	11000/-	
Installation	Noise level (H)	dB(A)	59	60	64	
	External dimensions (W/D/H)	mm	948/340/1250	948/340/1250	990/750/1750	
	Shipping dimensions (W/D/H)	mm	1095/410/1400	1095/410/1400	1160/940/1950	
	Net/Shipping weight	kg	108/118	106/111	161/185	
Working temp.	Compressor type (Scroll/Rotary)		Scroll	Scroll	Scroll	
	Cooling Normal	°C	10-46	10-43	10-43	
	Adapting fan speed controller	°C	/	-15-43	-15-43	
Heating	°C	-7-24	-7-24	-7-24		

\* Model is under development, data is for reference.

# Cabinet TYPE

AP422ACEAA  
AP48DS1ERA



Model/Indoor unit		AP422ACEAA	AP48DS1ERA *	AP48DS1ERA *	
Capacity	Cooling	Btu/h 42000	46000	49500	
		kW 12.3	13.5	14.5	
	Heating	Btu/h 47800	48500	53250	
Electrical		kW 14	14.2	15.6	
	Power supply	PhV/Hz 1/230/50	1/230/50	1/230/50	
	Air flow (H/M/L)	m³/h 1560	1750/1500/1350	1750/1500/1350	
Performance	Noise level (H/M/L)	dBA 56/46/40	48/44/40	48/44/40	
	External dimensions (W/D/H)	mm 530/340/1820	1824/529/380	1824/529/380	
	Shipping dimensions (W/D/H)	mm 620/420/1920	1965/625/465	1965/625/465	
	Net/Shipping weight	kg 52/61	55/62	55/62	
	Refrigerant liquid pipe	mm 9.52	9.52	9.52	
Installation	Refrigerant gas pipe	mm 19.05	19.05	19.05	
	Max pipe length	mm 50	50	50	
	Max drop between I.N.&O.U	m 30	30	30	
	Controller	Wired(O-optional, S-standard) Infrared(O-optional, S-standard)	YR-H71(S)	YR-E14(O) YR-HD(S)	YR-E14(O) YR-HD(S)
Model/Outdoor unit		AU42NALEAA	1U48LS1EAB *	1U48IS1EAB *	
Electrical parameters	Power supply	PhV/Hz 3/400/50	3/400/50	3/400/50	
	Power input	Cooling	kW 4.8	4.47	4.51
		Heating	kW 5.05	4.16	4.57
Performance	EER/COP	2.55/2.7	3.02/3.41	3.22/3.41	
	Energy class	E/E	B/B	A/B	
	Air flow (H)	m³/h 5500	4200	6500	
Installation	Noise level (H)	dBA 59	58	58	
	External dimensions (W/D/H)	mm 1008/410/830	1008/447/830	948/340/1250	
	Shipping dimensions (W/D/H)	mm 1130/490/930	1130/490/930	1095/410/1400	
	Net/Shipping weight	kg 91/102	95/105	108/118	
	Compressor type (Scroll/Rotary)	Scroll	Scroll	Scroll	
Working temp.	Cooling Normal	°C 10-43	10-46	10-46	
	Adopting fan speed controller	°C -15-43	/	/	
	Heating	°C -7-24	-7-24	-7-24	

\* Model is under development, data is for reference.



AP48KS1ERA  
AP482AKEAA  
AP60KS1ERA



Model/Indoor unit		AP48KS1ERA	AP48KS1ERA *	AP482AKEAA	AP60KS1ERA *	
Capacity	Cooling	Btu/h 48100	49500	46400	52900	
		kW 14.1	14.5	13.6	15.5	
	Heating	Btu/h 51500	53250	54600	58000	
Electrical		kW 15	15.6	16	17.0	
	Power supply	PhV/Hz 1/230/50	1/230/50	1/230/50	1/230/50	
	Air flow (H/M/L)	m³/h 1750/1500/1350	1750/1500/1350	1750/-/-	1750/1500/1350	
Performance	Noise level (H/M/L)	dBA 51/48/44	51/48/44	51/48/44	51/48/44	
	External dimensions (W/D/H)	mm 1850/600/350	1850/600/350	600/350/1850	1850/600/350	
	Shipping dimensions (W/D/H)	mm 1980/660/420	1980/660/420	660/420/1980	1980/660/420	
	Net/Shipping weight	kg 59/70	59/70	59/70	59/70	
	Refrigerant liquid pipe	mm 9.52	9.52	9.52	9.52	
Installation	Refrigerant gas pipe	mm 19.05	19.05	19.05	19.05	
	Max pipe length	mm 50	50	50	50	
	Max drop between I.N.&O.U	m 30	30	30	30	
	Controller	Wired(O-optional, S-standard) Infrared(O-optional, S-standard)	YR-E14(O) YR-HD(S)	YR-E14(O) YR-HD(S)	/ YR-H49(S)	YR-E14(O) YR-HD(S)
Model/Outdoor unit		1U48LS1EAB	1U48IS1EAB *	AU48NAIEAA	1U60IS1EAB *	
Electrical parameters	Power supply	PhV/Hz 3/400/50	3/400/50	3/400/50	3/400/50	
	Power input	Cooling	kW 4.67	4.51	4.5	5.15
		Heating	kW 4.42	4.57	5.25	5.29
Performance	EER/COP	3.02/3.42	3.22/3.41	3.02/3.05	3.01/3.21	
	Energy class	B/B	A/B	B/D	B/C	
	Air flow (H)	m³/h 4200	6500	8000	7000	
Installation	Noise level (H)	dBA 58	58	60	59	
	External dimensions (W/D/H)	mm 1008/447/830	948/340/1250	948/340/1250	948/340/1250	
	Shipping dimensions (W/D/H)	mm 1130/490/930	1095/410/1400	1095/410/1400	1095/410/1400	
	Net/Shipping weight	kg 95/105	108/118	106/111	108/118	
	Compressor type (Scroll/Rotary)	SCROOL	SCROOL	Scroll	SCROOL	
Working temp.	Cooling Normal	°C 10-46	10-46	10-43	10-46	
	Adopting fan speed controller	°C /	/	-15-43	/	
	Heating	°C -15-24	-7-24	-7-24	-7-24	

\* Model is under development, data is for reference.

<b>Product Line-up</b>	<b>123</b>
Outdoor	123
Indoor	125
<b>Benefits</b>	<b>127</b>
<b>Key Feature</b>	<b>133</b>
<b>Specifications</b>	
Outdoor	153
Indoor	157
<b>Control system</b>	<b>193</b>
<b>Accessories</b>	<b>199</b>



# MRV III

# Product Line-up

## OURDOOR

### Side Discharge



MRV III-S	3HP(1Ph)	5HP(1Ph)	5HP(3Ph)	7HP(3Ph)
Model	AU282FHARA	AU482FHARA(G)	AU48NFHARA(G)	AU60NFHARA(G)

### Side Discharge



MRV III-S	8HP(3Ph)	10HP(3Ph)	12HP(3Ph)
Model	AV08NMSETA	AV10NMSETA	AV12NMSETA

### Top Discharge



MRV III-C T1 (380-400V/3Ph/50/60Hz)	8-10HP	12-16HP	18-20HP	22-26HP
--	--------	---------	---------	---------

### Top Discharge



MRV III-C T1 (380-400V/3Ph/50/60Hz)	28-32HP	34-36HP	38-42HP	44-48HP
--	---------	---------	---------	---------

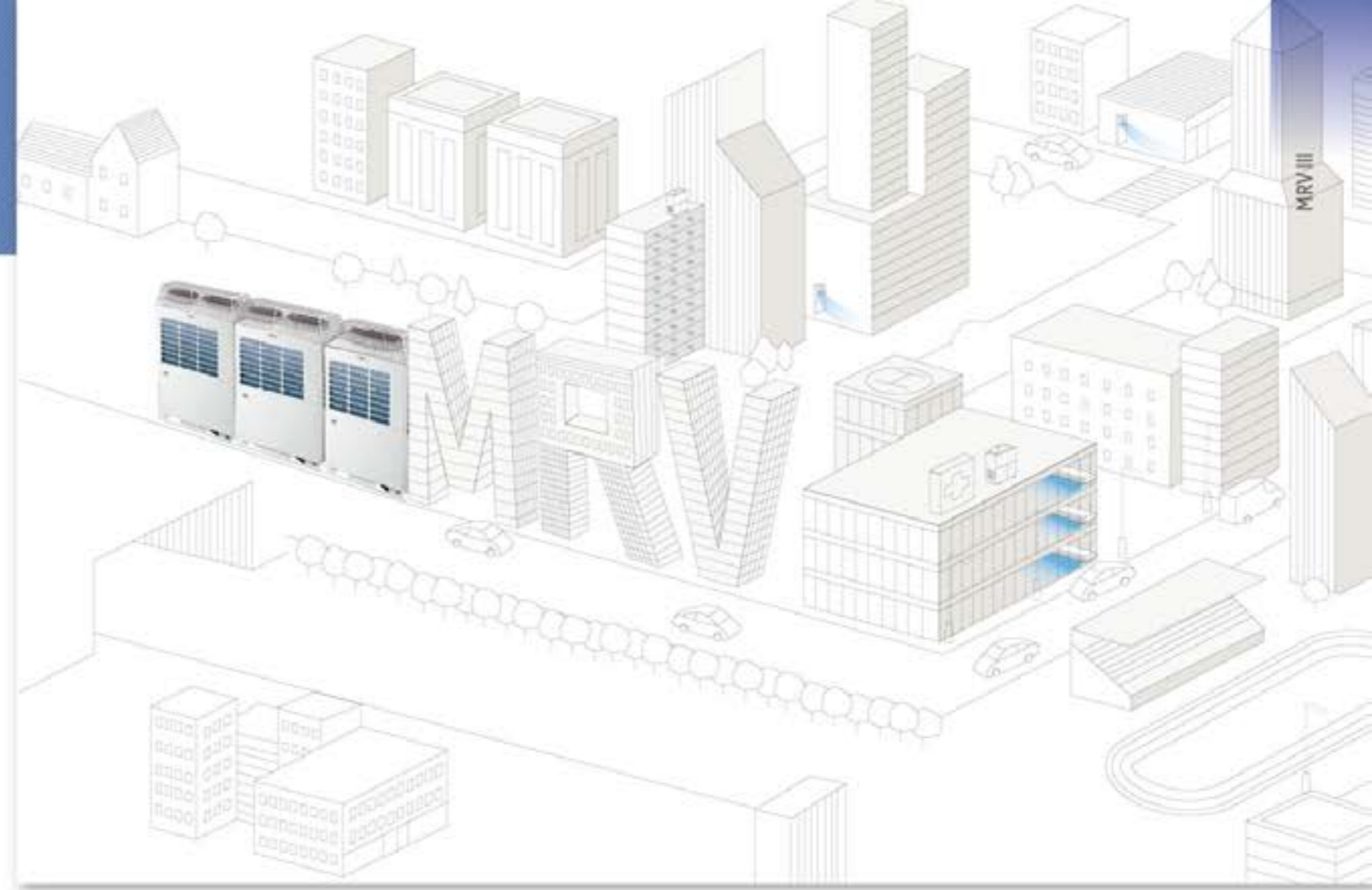

### MRV III-C T1 (380-400V/3Ph/50/60Hz)

Capacity	Model Name 380-400V/3Ph/50/60Hz	Combination Type					Connected Indoor Qty.	Gather Pipe
		8HP	10HP	12HP	14HP	16HP		
8HP	AV08NMVESA	1					13	without
10HP	AV10NMVESA		1				16	without
12HP	AV12NMVESA			1			19	without
14HP	AV14NMVESA				1		23	without
16HP	AV16NMVESA					1	26	without
18HP	AV18NMVESA	1	1				29	with
20HP	AV20NMVESA		2				33	with
22HP	AV22NMVESA		1	1			36	with
24HP	AV24NMVESA		1		1		39	with
26HP	AV26NMVESA		1			1	43	with
28HP	AV28NMVESA			1		1	46	with
30HP	AV30NMVESA				1	1	50	with
32HP	AV32NMVESA					2	53	with
34HP	AV34NMVESA		2		1		56	with
36HP	AV36NMVESA		2			1	59	with
38HP	AV38NMVESA	1	1			1	63	with
40HP	AV40NMVESA		1		1	1	64	with
42HP	AV42NMVESA		1			2	64	with
44HP	AV44NMVESA			1		2	64	with
46HP	AV46NMVESA				1	2	64	with
48HP	AV48NMVESA					3	64	with

# Product Line-up



## INDOOR

Btu/h kW	7000 2.2	9000 2.8	12000 3.6	16000 4.5	18000 5.6	24000 7.1	28000 8.0	30000 9.0	38000 11.2	48000 14.0	72000 22.6	96000 28
Cassette		AB092MCERA 	AB122MCERA 	AB162MCERA 	AB182MCERA 	AB242MCERA 	AB282MCERA 	AB302MCERA 	AB382MCERA 	AB482MCERA 		
2 Way Cassette	AB072MBERA 	AB092MBERA 	AB122MBERA 	AB162MBERA 	AB182MBERA 							
Convertible		AC092MCERA 	AC122MCERA 	AC162MCERA 	AC182MCERA 	AC242MCERA 	AC282MEERA 	AC302MEERA 	AC382MFERA 	AC482MFERA 		
Slim Low ESP Duct (0/30Pa)	AD072MSERA 	AD092MSERA 	AD122MSERA 	AD162MSERA 	AD182MSERA 	AD242MSERA 						
Low ESP Duct (0/20Pa)	AD072MLERA 	AD092MLERA 	AD122MLERA 	AD162MLERA 	AD182MLERA 	AD242MLERA 						
Medium ESP Duct (50/96Pa)					AD182MMERA 	AD242MMERA 	AD282MMERA 	AD302MMERA 	AD382MMERA 	AD482MMERA 		
Medium ESP Duct (80/120Pa)					AD182MZERA 	AD242MZERA 	AD282MZERA 	AD302MNERA 	AD382MNERA 	AD482MNERA 		
High ESP Duct (100/196Pa)					AD182MHERA 	AD242MHERA 	AD282MHERA 	AD302MHERA 	AD382MHERA 	AD482MHERA 	AD722MHERA 	AD962MHERA 
Fresh Air Duct										AD482MPERA 	AD722MPERA 	AD962MPERA 
Built-in Floor Standing	AE072MLERA 	AE092MLERA 	AE122MLERA 	AE162MLERA 	AE182MLERA 	AE242MLERA 						
Console	AF072MAERA 	AF092MAERA 	AF122MAERA 		AF182MAERA 							
High Wall EEV Inside	AS072MGERA 	AS092MGERA 	AS122MGERA 	AS162MGERA 	AS182MGERA 	AS242MGERA 						
HRV (Heat Reclaim Ventilation)	ERV0150ANN 	ERV0260ANN 	ERV0800ANN 	ERV1000ANN 								





# Benefits



SERIES	MODEL	ENERGY SAVING			INTELLIGENT & COMFORT							HEALTH			CONVENIENT			DESIGN						
		DC motor	High performance compressor	180° sine wave DC inverter	Super quiet	On-Off card	Group control	Central control	Left/Right airflow	Quiet operation	Auto-swing	4-way airflow	Oy-refresh	Oy-fresh	Clean air	Auto restart	3 minutes protection	24 hours timer	Compact design	Low ambient cooling (LPC)	Low ambient heating (HSPC)	Blue fin	Low ambient heating	Drain water pump
High ESP Duct (AD**MHERA)	AD182MHERA					✓	✓	✓						✓	✓	✓	✓		✓	✓	✓	✓		
	AD242MHERA					✓	✓	✓						✓	✓	✓	✓		✓	✓	✓	✓		
	AD282MHERA					✓	✓	✓						✓	✓	✓	✓		✓	✓	✓	✓		
	AD302MHERA					✓	✓	✓						✓	✓	✓	✓		✓	✓	✓	✓		
	AD382MHERA					✓	✓	✓						✓	✓	✓	✓		✓	✓	✓	✓		
	AD482MHERA					✓	✓	✓						✓	✓	✓	✓		✓	✓	✓	✓		
	AD722MHERA					✓	✓	✓						✓	✓	✓	✓		✓	✓	✓	✓		
Fresh Air Duct (AD**2MPERA)	AD962MHERA					✓	✓	✓						✓	✓	✓	✓		✓	✓	✓	✓		
	AD482MPERA					✓	✓	✓						✓	✓	✓	✓		✓	✓	✓	✓		
	AD722MPERA					✓	✓	✓						✓	✓	✓	✓		✓	✓	✓	✓		
Built-in Floor Standing (AE**2MLERA)	AD962MPERA					✓	✓	✓						✓	✓	✓	✓		✓	✓	✓	✓		
	AE072MLERA					✓		✓					✓	✓	✓	✓	✓	✓	✓	✓	✓	✓		✓
	AE092MLERA					✓		✓					✓	✓	✓	✓	✓	✓	✓	✓	✓	✓		✓
	AE122MLERA					✓		✓					✓	✓	✓	✓	✓	✓	✓	✓	✓	✓		✓
	AE162MLERA					✓		✓					✓	✓	✓	✓	✓	✓	✓	✓	✓	✓		✓
Console	AE182MLERA					✓		✓					✓	✓	✓	✓	✓	✓	✓	✓	✓	✓		✓
	AE242MLERA					✓		✓					✓	✓	✓	✓	✓	✓	✓	✓	✓	✓		✓
	AF072MAERA					✓	✓	✓						✓	✓	✓	✓		✓	✓	✓	✓		✓
	AF092MAERA					✓	✓	✓						✓	✓	✓	✓		✓	✓	✓	✓		✓
	AF122MAERA					✓	✓	✓						✓	✓	✓	✓		✓	✓	✓	✓		✓
High Wall (AS**2MSERA) EEV Inside	AF182MAERA					✓	✓	✓						✓	✓	✓	✓		✓	✓	✓	✓		✓
	AS072MGERA	✓				✓		✓					✓	✓	✓	✓	✓		✓	✓	✓	✓		✓
	AS092MGERA	✓				✓		✓					✓	✓	✓	✓	✓		✓	✓	✓	✓		✓
	AS122MGERA	✓				✓		✓					✓	✓	✓	✓	✓		✓	✓	✓	✓		✓
HRV (Heat Reclaim Ventilation) ERV****ANN	AS162MGERA	✓				✓		✓					✓	✓	✓	✓	✓		✓	✓	✓	✓		✓
	ERV0150ANN							✓					✓	✓	✓	✓	✓		✓	✓	✓	✓		✓
	ERV0260ANN							✓					✓	✓	✓	✓	✓		✓	✓	✓	✓		✓
	ERV0800ANN							✓					✓	✓	✓	✓	✓		✓	✓	✓	✓		✓
	ERV1000ANN							✓					✓	✓	✓	✓	✓		✓	✓	✓	✓		✓



## DC INVERTER TWIN ROTARY COMPRESSOR (AU28)

Realize high efficiency and compact designed compressor by joint wrap & earth's metal magnet motor.  
Wide range inverter compressors would satisfy the customer's innovative requirement and design.

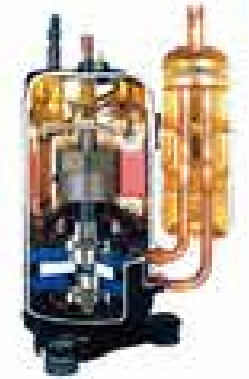

## DC INVERTER TWIN ROTARY COMPRESSOR (AU48/60)



## DC INVERTER TECHNOLOGY

### DC inverter motor

DC fan motor speed can be adjusted from 0-1000 r/min, it can improve the unit efficiency, at the same time, the unit can realize low ambient cooling operation.

- High efficiency
- Low vibration, low noise
- High reliability



- > Large capacity side discharge outdoor unit
- > Compact design
- > Easy and efficient installation
- > Built-in stop valve
- > 4 way piping is possible (Front, Rear, Right, Down)



8/10/12HP



4-Way

# MRV III-S

KEY FEATURE

# MRV III-S Key Feature



## PRECISE CONTROL

PID control adjusts the output of compressor and the open degree of EEV, balances the indoor refrigerant flow, realizes the linear output, creates a comfortable environment. The temperature could be controlled precisely.

- Proportion adjustment
- Integral adjustment
- Differential adjustment

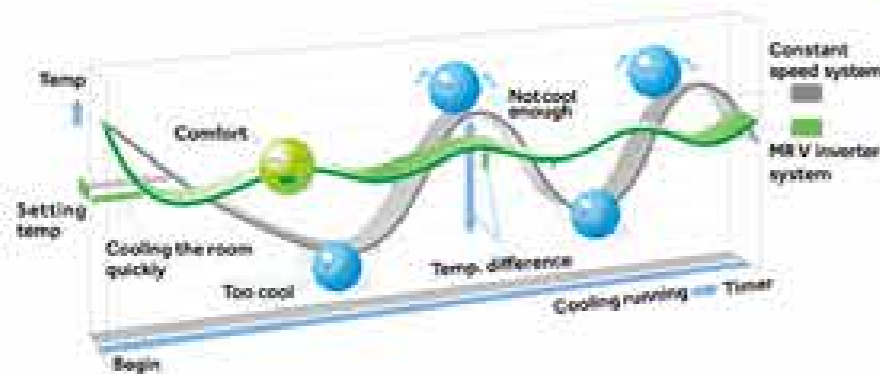
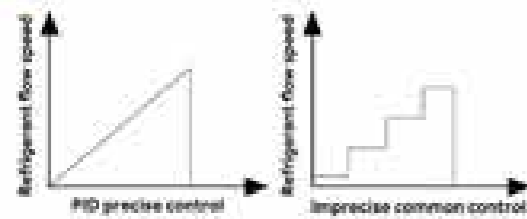

## 180° VECTOR CONTROL TECHNOLOGY

Haier using power resistance to detect the rotor position of compressor, results in the consistency of the compressor working current and current sine waves, improve power efficiency about 1.7%.

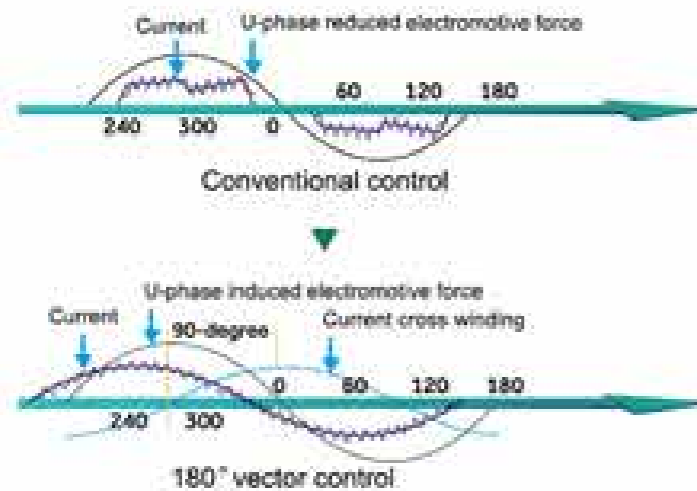

## OPERATION RANGE

- > MRV III-S series permits a system design considering a heating range operation under a low temperature condition from -15°C of previous model and a cooling range operation -5°C.
- > For the capacities under low temperature conditions, please see technical data sheets.



## SIDE DISCHARGE MRV III-S OUTDOOR UNITS

Dual Frequency 50/60Hz  
DC Inverter TWIN Rotary Compressor  
BLDC Fan (BrushLess DC motor)



15kW 1 Phase  
15kW 3 Phase  
18kW 3 Phase

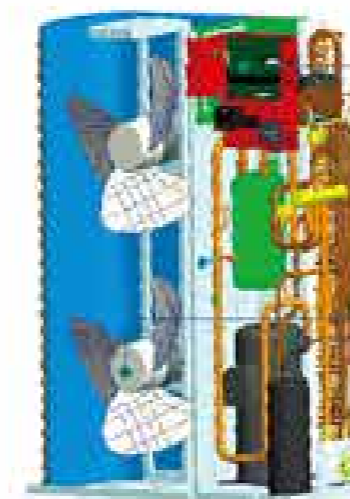

- Control the compressor running frequency by temp. Sensor, more precise and prompt than conventional control system.
- Protections: Pressure, temp., compressor, fan motor, refrigerant, oil quantity etc. Realize perfect performance.
- Malfunction self-diagnose.
- DC fan motor (AU48/60).
- DC inverter compressor, high efficiency.
- Single set valve, easy to installation and save installation time.



# PERFECT OUTDOOR STRUCTURE

## AIR SUPPLY CHAMBER AND EQUIPMENT CHAMBER SEPARATION DESIGN

- ① Prevent electrical parts and the main functional components by the rain Erosion, **prolong the service life of components;**
- ② Compressor running noise was closed in the equipment room, **reduce the running noise about 3 dB(A);**
- ③ Air supply chamber complete isolation: During commissioning and maintenance, **the units can be used normally.**

- ③ Air supply chamber
- Drain pan
- Equipment chamber
- ① Electrical parts
- ② Compressor

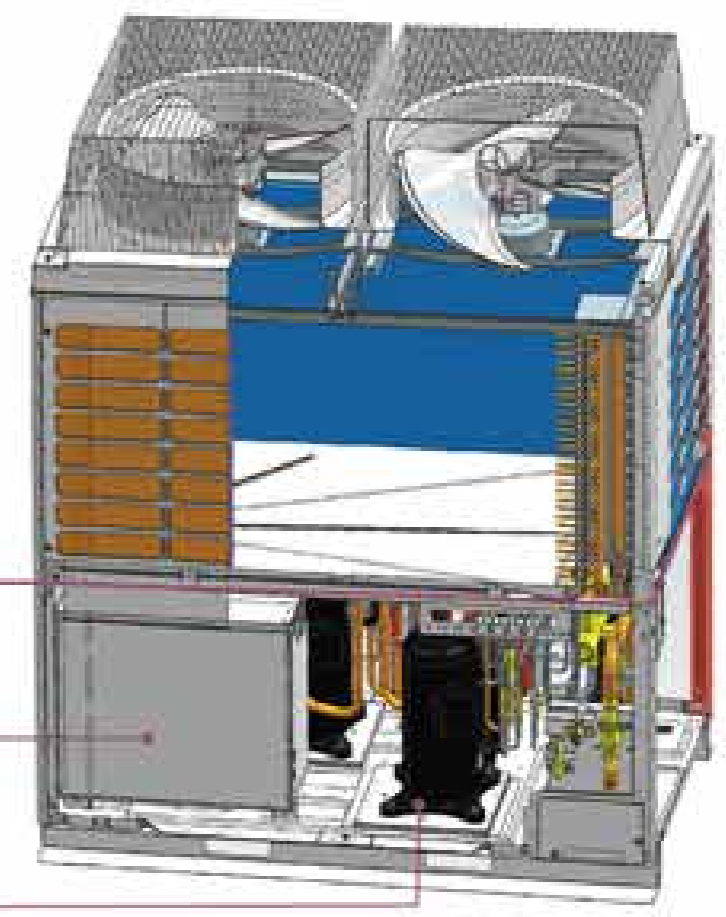

**MRV III -C**  
KEY FEATURE



## SPECIAL HEAT EXCHANGER DESIGN

### 4 way air return heat exchanger design

Reduce the heat exchanger height (650mm), and the upper and lower wind speed uniform and high efficiency.



### Two stages heat exchanger design

Two stages heat exchanger can separate control and adjust heat exchanger size, effectively cope with small load operation, to ensure the reliable operation range.

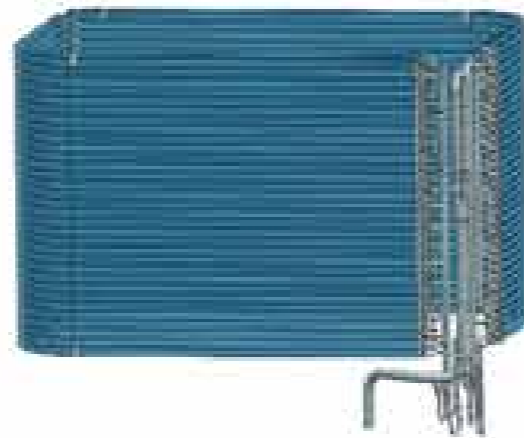

### Double EEV design

The two stage heat exchanger are respectively controlled by a electronic expansion valve control which can adjust the condenser volume.



## SPECIAL HEAT EXCHANGER DESIGN

### Aviation noise reduction patent fan design

Streamline vortex fan, sharp fan blade edge, and a certain degree of curvature, reduce the vibration, and pressure loss.

### DC fan motor

- > DC inverter technology
- > High efficiency
- > Low noise



### 1 New fan with aviation design



### 2 DC fan motor

- High efficiency
- Low noise
- DC inverter



## ELECTRIC CONTROL BOX HEAT DISSIPATION DESIGN

Streamline vortex fan forced heat dissipation fan inside the electric control box, to ensure the stable internal temperature and stable system operation, sharp fan blade edge, and a certain degree of curvature, reduce the vibration, and pressure loss.



# ENERGY EFFICIENT



## 64 STAGE SPEED ADJUSTMENT DC FAN MOTOR

- > Efficiency increase 45% comparing with AC motor and power input largely decrease.
- > 64 stage speed adjustment plus DC inverter drive, stabilizing compressor discharge pressure and suction pressure to ensure high system reliability.

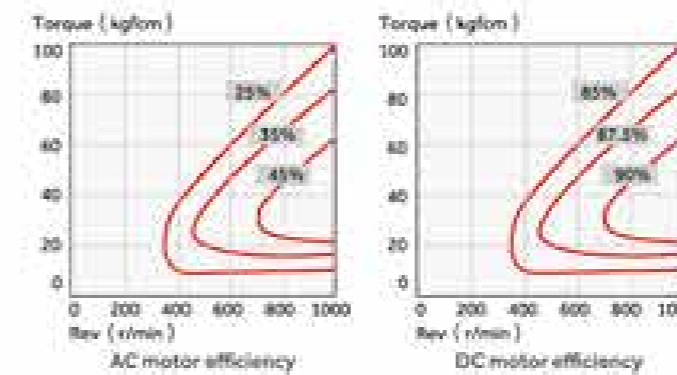

## HIGH EFFICIENCY DC INVERTER SCROLL COMPRESSOR



- > DC inverter scroll compressor imported from mitsubishi electric.
- > Equipped with a "Frame Compliance Mechanism" that allows movement in the axial direction of the frame supporting the cradle scroll. This greatly reduces both leakage and friction loss, ensuring very high efficiency throughout the whole speed range.

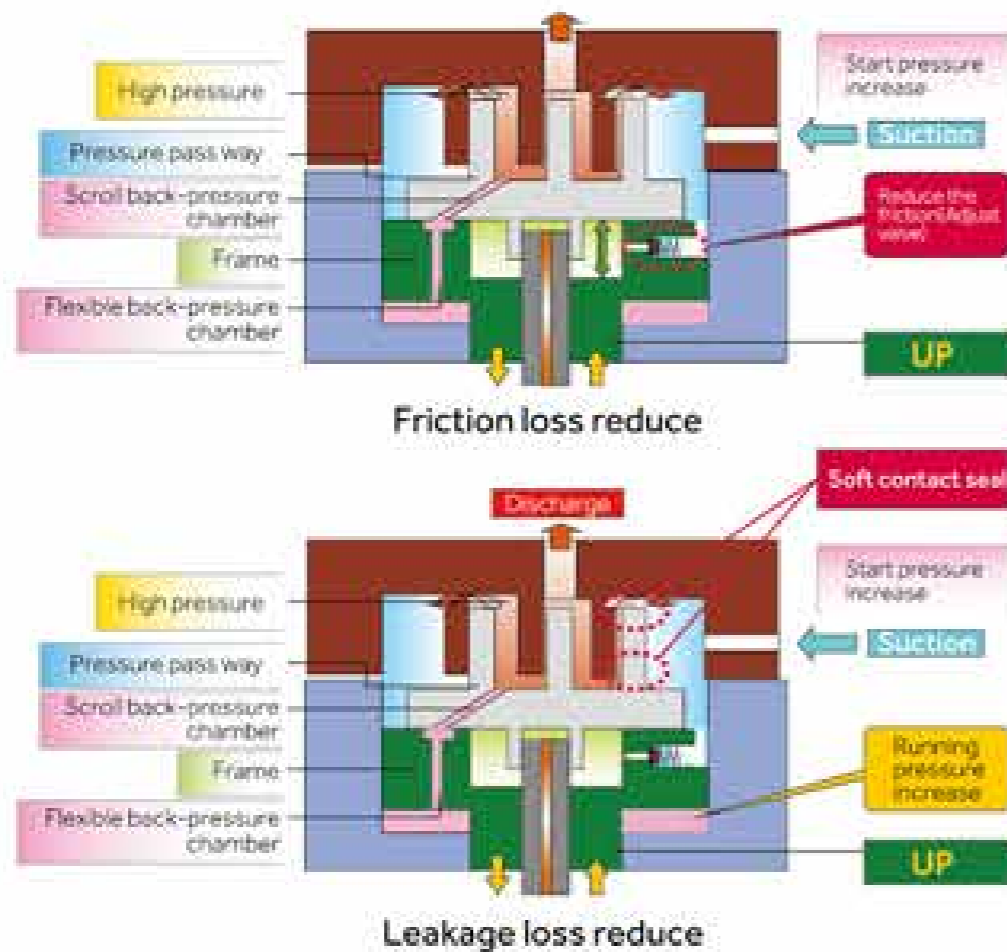

## STEPLESS DC INVERTER CONTROL TECHNOLOGY

High precision control, variable frequency drive from 0 to 360Hz.

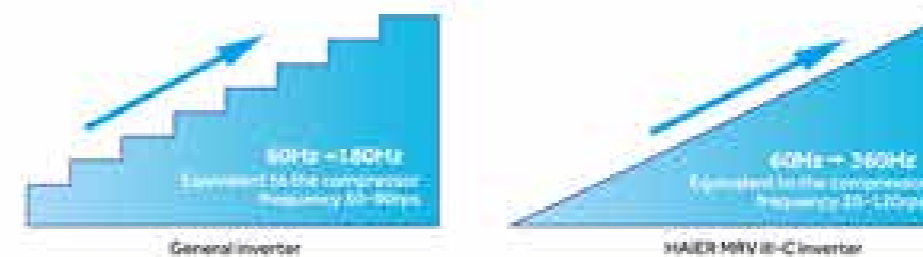

180° vector, dc inverter drive technology. Sine wave current drive, efficiency improve 17% comparing to conventional rectangle wave.

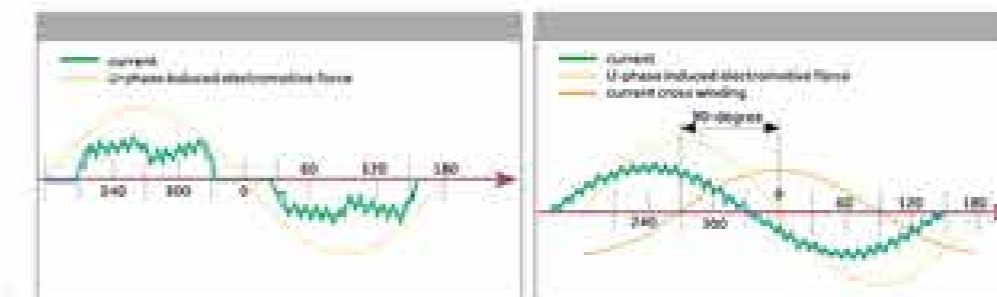

# MRV III-C Energy Efficient

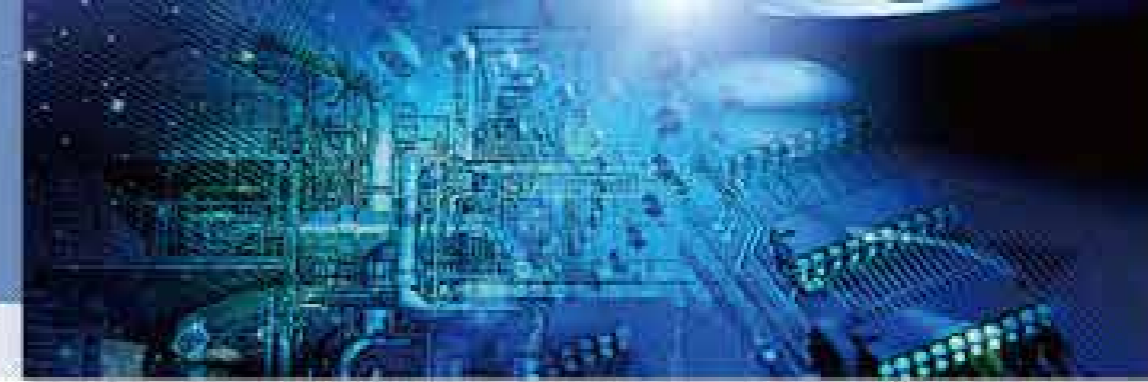

## TWO STAGE DEEP SUB COOLING TECHNOLOGY

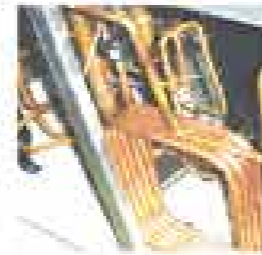

- > 1st stage sub cooling added a sub cooling coil to condenser.
- > 2nd stage sub cooling added a stand alone sub cooler
- > After further cooling, sub-cooling degree can be up to 30°C, with the heat exchanging capacity per unit mass of refrigerant improved by 46% and flow resistance reduced by 55%, and running efficiency improved by 9%.

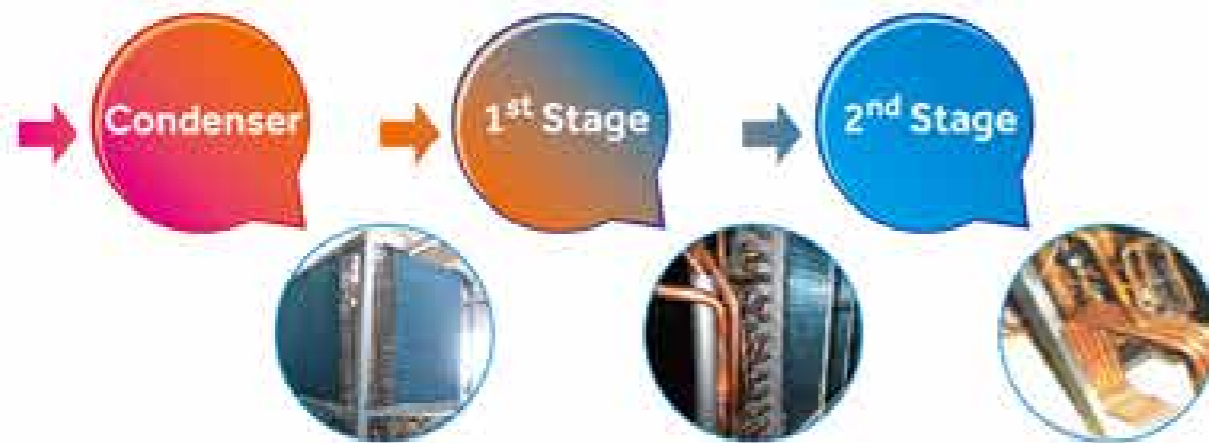

## ENERGY MANAGEMENT TECHNOLOGY

- > There is energy saving dip switch (SW8-3) in the indoor unit which can be lock the temperature at 26°C in summer and 20°C in winter, to avoid the energy waste and realize the centralized management.
- > The temperature lock function also can be realized through the new wired controller YR-E15.



## HIGH EFFICIENCY HEAT EXCHANGING TECHNOLOGY

- > Outdoor high efficiency four way air return heat exchanger design.
- > The compressor and condenser are placed in separated chamber.
- > High efficiency heat exchanger design.
- > Efficient ø8 inner grooved tube and 0.11 hydrophilic aluminum coil fin, corrosion and oxidation resistance treatment.

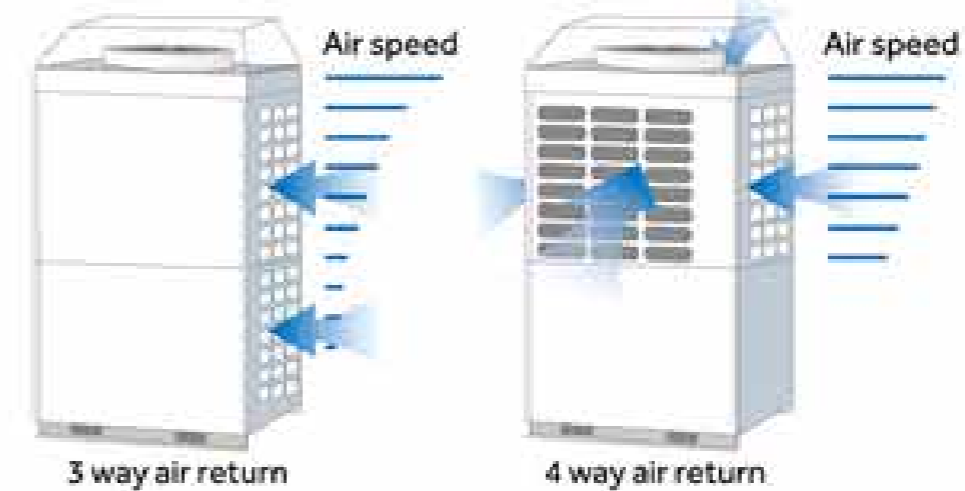

### TWO TO ONE Refrigerant circle design

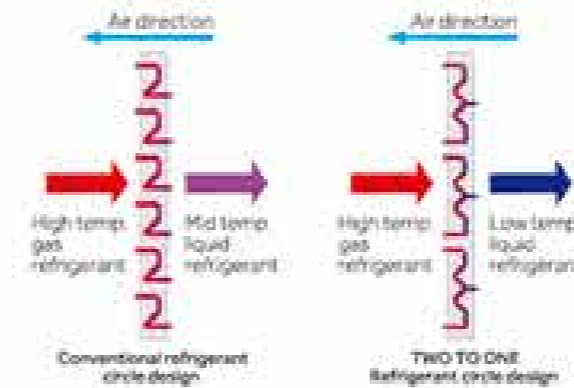

### Coil fin and tube

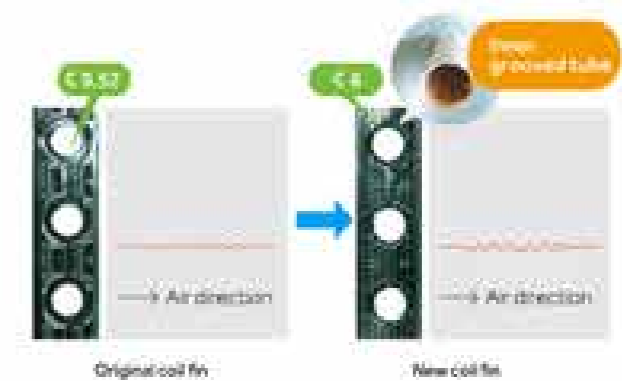

# COMFORT



## PRECISE CONTROL

Adopt the inverter control, the temperature could be control precisely within the range of  $\pm 0.5^{\circ}\text{C}$ .

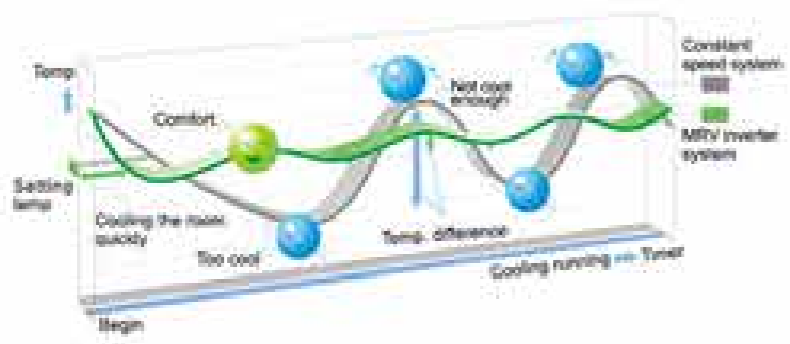

## LOW NOISE AND NIGHT SILENT RUNNING

- > Machinery chamber is separated from air supply chamber. Built-in high efficient muffler in the machinery chamber greatly reduce the compressor noise.
- > The night silent running function can be set on the outdoor PCB. The noise can be reduced by 8 dB(A) at most.

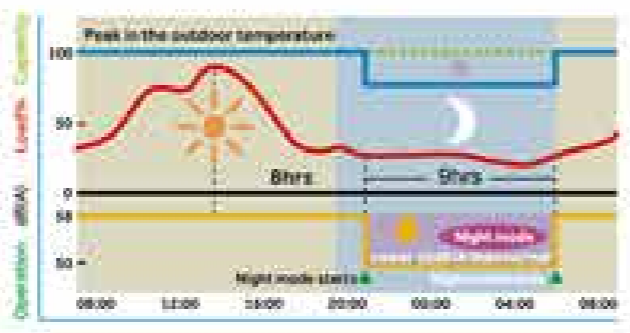

## DOUBLE EEV CONTROL

Make sure the refrigerant flow equally, to provide more comfort temperature.

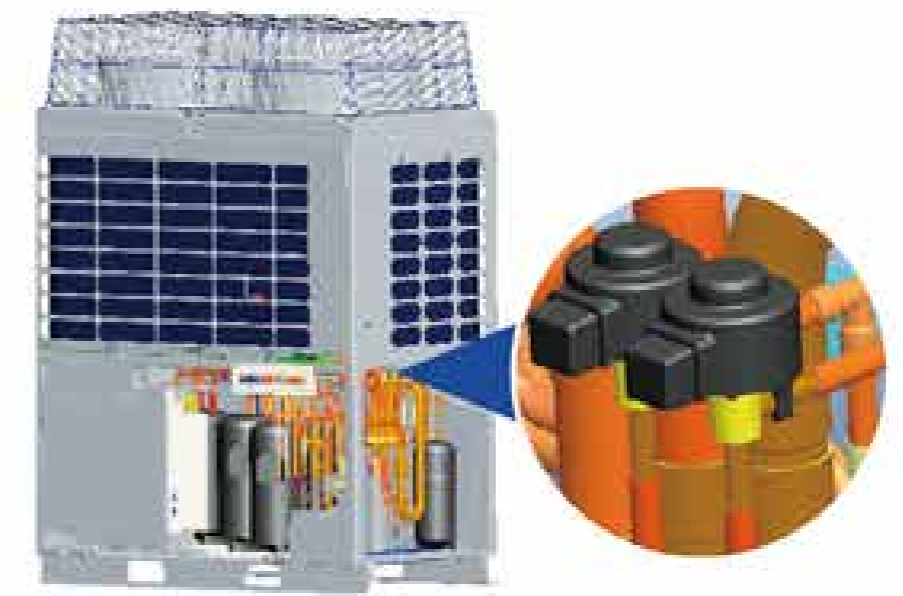

## PRIORITY SETTING

With the human design, you can set different preferential steps of some indoor units according to the room functions, so that it will ensure that the most important room gains high priority.



- A: Boss Office
- B: Anesthichamber
- C: Office
- D: Office

## CONVINENT INSTALLATION

### EASY TRANSPORTATION

- > Outdoor footprint only occupy 0.74m<sup>2</sup>(8/10HP) and 1.04m<sup>2</sup>(12/14/16HP).
- > Can lift with elevators and save lots of transport cost and time.



### LONG PIPE LENGTH, HIGH HEIGHT DROP

- > Total 300m refrigerant piping length.
- > Max. 150m refrigerant piping length.
- > Max. 50m height drop between indoor and outdoor units.
- > Max. 15m height drop between indoor units.

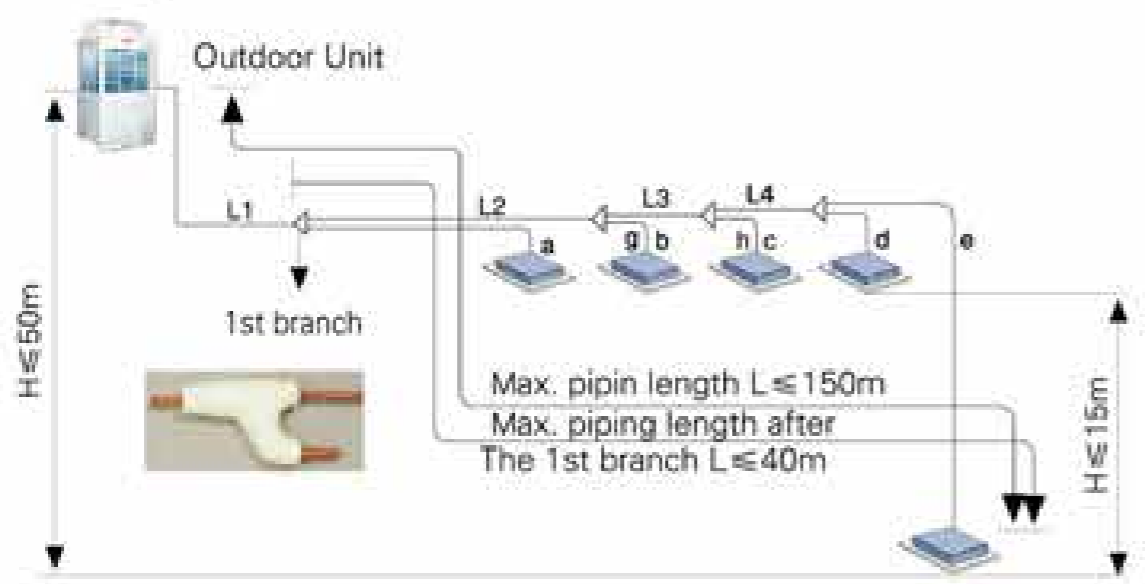

### OUTDOOR HIGH EXTERNAL STATIC PRESSURE

Up to 50Pa and can be installed at different floors.



### CONNECTION WIRE

- > Two core nonpolar communication line way, no joint wrong hidden trouble.
- > Centralized controller bus and indoor/outdoor bus shareable, wiring and access is very simple indoor address automatically set.

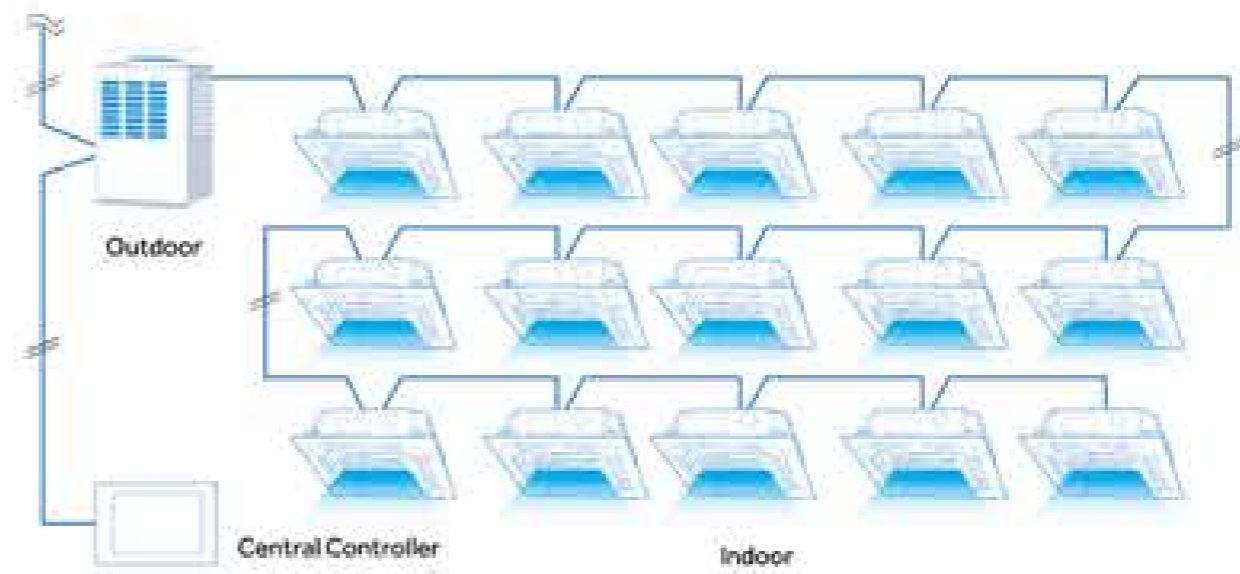

# HIGH RELIABILITY



# High Reliability

## COMPRESSOR ANTI-LIQUID SHOCK TECHNOLOGY

Compressor adopt flexible frame mechanism, when any liquid enter into compressor, cradle scroll detaching fixed scroll, discharging liquid refrigerant out of scroll set, to avoid scroll damage.

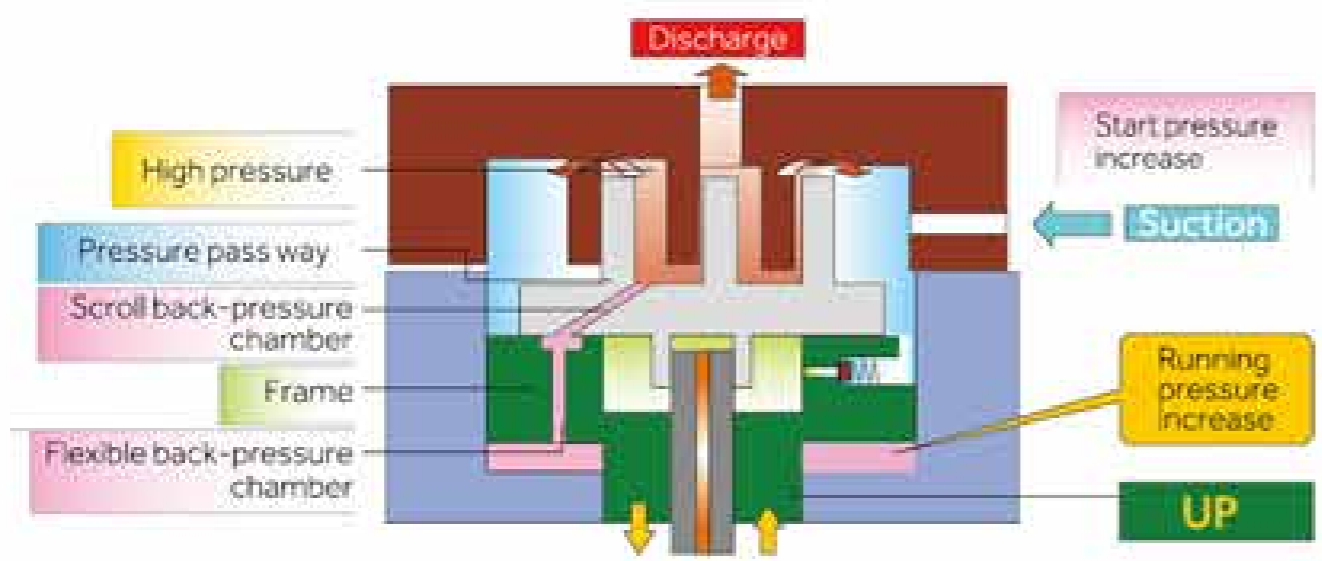

## THE FIRST 2-STAGES OIL SEPARATION AND CROSS OIL RETURN TECHNOLOGY IN THE INDUSTRY

- > 1<sup>st</sup> stage oil separation: built-in oil separating unit, greatly reduced the oil from the compressor discharge.
- > 2<sup>nd</sup> stage oil separation: external oil separator to separate the small amount of oil from discharge.

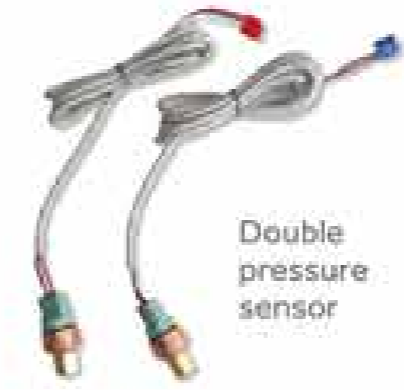

Double pressure sensor



## HIGH PRESSURE DIFFERENCE OIL EQUALIZATION

Using the pressure difference between suction and discharge, to realize fast oil balance between module.

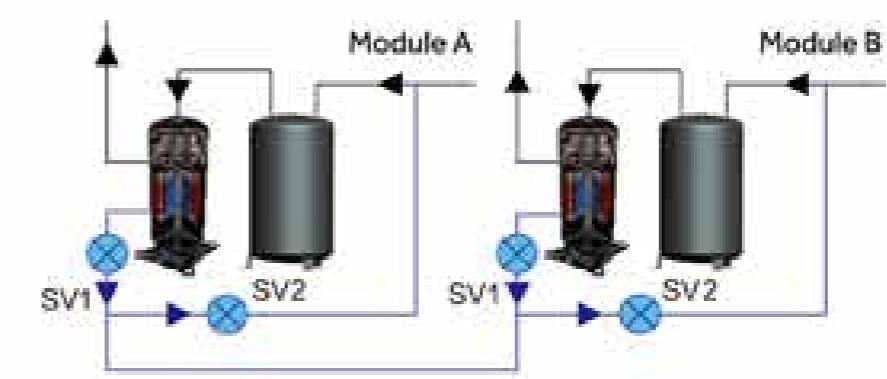

Flow	a → b	b → a
ON	SV1a SV2b	SV1b SV2a
OFF	SV1b SV2a	SV1a SV2b



## DUTY CYCLE OPERATION TO EXTEND THE SYSTEM LIFETIME (Combination Model)

- > The outdoor units priority operating changes every 24 hours.
- > Outdoor units start in turn and operation time can be balanced.
- > Inverter compressor lifetime can be extend maximum 3 times.



## BACKUP OPERATION

If one outdoor unit get into malfunction, the other units continue to operate without affecting the whole system.



## FIELD TEST

The system has been running for over 3 years at the jobsite where the vertical height approximately to 100m.

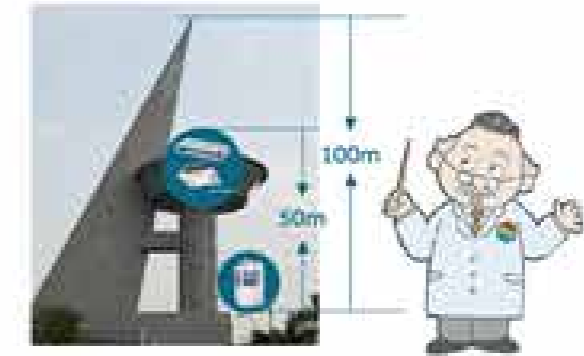

## TEST LAB.



## SUPPORTING TOOLS

### MRV design express

This software supply a solution of piping & wiring design, can help the designer select the right material lists, basic wiring diagram and control wiring diagram etc... most important thing is to save lots of time during design procedure.

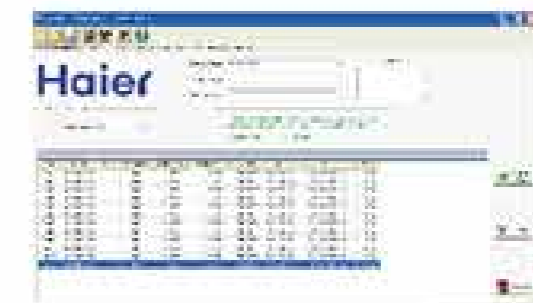

### On-site service software

Features:  
Save the installation and maintenance people time.  
More precise than normal checking method.

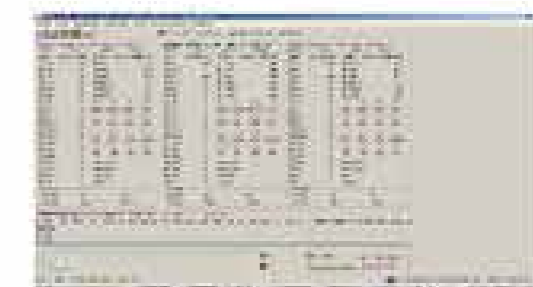

AU282FHera

- AU482Fiera(G)
- AU48NFiera(G)
- AU60NFiera(G)

- AV08NMSetA
- AV10NMSetA
- AV12NMSetA



Model		AU282FHera	AU482Fiera(G)	AU48NFiera(G)	AU60NFiera(G)	AV08NMSetA	AV10NMSetA	AV12NMSetA	
Capacity	Capacity range	3HP	5HP	5HP	7HP	8HP	10HP	12HP	
	Cooling	kBtu/h	27.3	51.2	51.2	61.4	77.1	95.5	114.3
	Heating	kBtu/h	32.4	58	58	68.2	85.3	107.5	128
Electrical parameters	Power supply	Ph/V/Hz	1/220-230/50	1/220-230/50/60	3/380-400/50/60	3/380-400/50/60	3/380-400/50/60	3/380-400/50/60	3/380-400/50/60
	Power input (Cooling)	kW	2.2	4.2	4.2	5.5	6.5	8.5	10.9
	Power input (Heating)	kW	2.15	4	4	5.25	6.1	7.9	10.5
Performance	EER/COP		3.64/4.42	3.57/4.25	3.57/4.25	3.27/3.8	3.48/4.1	3.29/3.99	3.07/3.57
	Air flow (l/s)	m³/h	3500	6500	6500	6500	10000	10000	10000
	Sound pressure level (l/s)	dBA	55	59	59	60	56	58	60
	Sound power level (l/s)	dBA	66	70	70	71	67	69	71
Installation	External dimensions(W/D/H)	mm	960/380/830	960/380/1250	960/380/1250	960/380/1250	1050/400/1620	1050/400/1620	1050/400/1620
	Shipping dimensions(W/D/H)	mm	1095/410/985	1095/410/1400	1095/410/1400	1095/410/1400	1090/510/1800	1090/510/1800	1090/510/1800
	Net/Shipping weight	kg	74/89	105/113	105/113	105/113	168/180	168/180	168/180
	Compressor type		Rotary	Rotary	Rotary	Rotary	Rotary	Rotary	Rotary
	Compressor brand		MITSUBISHI	MITSUBISHI	MITSUBISHI	MITSUBISHI	MITSUBISHI	MITSUBISHI	MITSUBISHI
Connection ratio	Compressor quantity	kg	14	21.6	21.6	21.6	24	24	24
	Refrigerant type		R410A	R410A	R410A	R410A	R410A	R410A	R410A
	Refrigerant charge	kg	2.6	3.6	4	4	6.6	6.6	6.6
	Refrigerant liquid pipe	mm	9.52	9.52	9.52	9.52	9.52	12.7	12.7
	Refrigerant gas pipe	mm	15.88	19.05	19.05	19.05	19.05	22.22	25.4
	Max pipe length	m	50	100	100	100	300	300	300
Working temp.	Max drop between I.U.&O.U	m	30	30	30	30	50	50	50
	Connectable indoor unit ratio	%	50-130	50-130	50-130	50-130	50-130	50-130	50-130
Working temp.	Maximum number of indoor units		4	8	8	9	13	16	19
	Cooling	°C	-5-43	-5-43	-5-43	-5-43	-5-43	-5-43	-5-43
	Heating	°C	-15-21	-15-21	-15-21	-15-21	-15-21	-15-21	

\* All the specifications are tested under normal condition cooling. Indoor temp is 27°C DB/19°C WB. Outdoor temp is 35°C DB/24°C WB. In heating, indoor temp is 20°C DB. Outdoor temp is 7°C DB/9°C WB. 8/10/12HP will be launched in June, 2015.

# MRV III OUTDOOR

OUTDOOR MODELS

# MRV8-C(T1) 380-400V/3Ph/50/60Hz



- > Dual Frequency 50/60Hz-380V-3Ph
- > Dc Inverter Scroll Compressor & Bldc Fan
- > New Basic Modular Units: 12HP, 14HP, 16HP
- > Free Combination Up To 48HP With Incremental 2HP
- > Max. Indoor Units Up To 64



Model		AV08MVESA	AV10MVESA	AV12MVESA	AV14MVESA	AV16MVESA	AV18MVESA	AV20MVESA	AV22MVESA	AV24MVESA	AV26MVESA	AV28MVESA	AV30MVESA	AV32MVESA	AV34MVESA	AV36MVESA	AV38MVESA	AV40MVESA	AV42MVESA	AV44MVESA	AV46MVESA	AV48MVESA		
Combination model		/	/	/	/	/	AV08MVESA AV10MVESA	AV10MVESA AV12MVESA	AV12MVESA AV14MVESA	AV14MVESA AV16MVESA	AV16MVESA AV18MVESA	AV18MVESA AV20MVESA	AV20MVESA AV22MVESA	AV22MVESA AV24MVESA	AV24MVESA AV26MVESA	AV26MVESA AV28MVESA	AV28MVESA AV30MVESA	AV30MVESA AV32MVESA	AV32MVESA AV34MVESA	AV34MVESA AV36MVESA	AV36MVESA AV38MVESA	AV38MVESA AV40MVESA		
Capacity	Capacity range	HP	8	10	12	14	16	18	20	22	24	26	28	30	32	34	36	38	40	42	44	46	48	
	Cooling	kW	22.6	28	33.5	40	45	50.6	56	61.5	68	73	78.5	85	90	96	101	106.5	111	116	121.5	130	135	
	Heating	kW	25	31.5	37.5	45	50	56.5	63	69	76.5	81.5	87.5	95	100	108	113	119	126.5	131.5	137.5	145	150	
Electrical parameters	Power supply	Ph/V/Hz	3/380-400/50/60	3/380-400/50/60	3/380-400/50/60	3/380-400/50/60	3/380-400/50/60	3/380-400/50/60	3/380-400/50/60	3/380-400/50/60	3/380-400/50/60	3/380-400/50/60	3/380-400/50/60	3/380-400/50/60	3/380-400/50/60	3/380-400/50/60	3/380-400/50/60	3/380-400/50/60	3/380-400/50/60	3/380-400/50/60	3/380-400/50/60	3/380-400/50/60	3/380-400/50/60	
	Cooling	Rated power input	kW	5.27	7.36	10	11.4	13.4	12.63	14.72	17.36	18.76	20.76	23.4	24.8	28.8	26.12	30.76	32.16	34.16	36.8	38.2	40.2	
		Max power input	kW	12.37	14.7	17.54	18.55	20.48	27.07	29.4	29.91	33.25	35.18	37.1	39.05	40.96	47.95	49.88	51.8	53.73	55.66	58.5	59.51	61.44
	Heating	Rated power input	kW	5.89	7.97	10	11.6	13.5	13.96	15.94	17.97	19.57	21.47	23.5	25.1	27	27.54	29.4	31.47	33.07	34.97	37	38.5	40.5
		Max power input	kW	9.77	11.9	14.6	16.6	17.8	21.67	23.8	24.37	28.5	29.7	33.2	34.4	35.6	40.4	41.6	45.1	46.3	47.5	50.2	52.2	53.4
	EER	Rated current	A	8.7	11.1	14.2	15.05	20.3	19.8	22.2	25.3	30.15	31.4	34.5	39.35	40.6	41.25	42.5	45.6	50.45	51.7	54.8	59.65	60.9
		Max current	A	19.85	23.4	27.9	29.5	32.57	43.25	46.8	47.75	52.5	55.77	59	61.87	64.74	76.3	79.17	82.4	85.27	88.14	92.64	94.24	97.11
		Max current	A	15.7	19	23.3	26.5	28.4	34.7	38	39	44.5	47.4	53	54.9	56.8	64.5	66.4	72	73.9	75.8	80.1	83.3	85.2
	Performance	EER		4.29	3.80	3.35	3.51	3.36	4.01	3.80	3.54	3.62	3.52	3.35	3.43	3.36	3.68	3.59	3.46	3.51	3.45	3.36	3.40	3.36
		COF		4.24	3.95	3.75	3.88	3.70	4.08	3.95	3.84	3.91	3.80	3.72	3.78	3.70	3.92	3.84	3.78	3.83	3.76	3.72	3.76	3.70
Performance	Air flow (H)	m³/h	11000	13000	14100	14300	14100	22200	22200	25200	25200	25200	28200	28200	28200	36300	36300	39300	39300	39300	42300	42300	42300	
	Sound pressure level (H)	dBA	57	57	60	60	60	60	60	61	61	61	62	62	62	63	63	63	63	63	64	64	64	
	Sound power level (H)	dBA	73	73	76	76	76	77	77	78	78	78	79	79	79	81	81	81	81	81	82	82	82	
Installation	External dimensions (W/D/H)	mm	990/750/1808	990/750/1808	1390/750/1808	1390/750/1808	1390/750/1808	990/750/1808 +990/750/1808	990/750/1808 +990/750/1808	990/750/1808 +1390/750/1808	990/750/1808 +1390/750/1808	990/750/1808 +1390/750/1808	1390/750/1808 +1390/750/1808	1390/750/1808 +1390/750/1808	1390/750/1808 +1390/750/1808	990/750/1808 +1390/750/1808	990/750/1808 +1390/750/1808	990/750/1808 +1390/750/1808	990/750/1808 +1390/750/1808	990/750/1808 +1390/750/1808	1390/750/1808 +1390/750/1808	1390/750/1808 +1390/750/1808	1390/750/1808 +1390/750/1808	
	Shipping dimensions (W/D/H)	mm	1090/860/1990	1090/860/1990	1490/860/1990	1490/860/1990	1490/860/1990	1090/860/1990 +1090/860/1990	1090/860/1990 +1090/860/1990	1090/860/1990 +1490/860/1990	1090/860/1990 +1490/860/1990	1090/860/1990 +1490/860/1990	1490/860/1990 +1490/860/1990	1490/860/1990 +1490/860/1990	1490/860/1990 +1490/860/1990	1090/860/1990 +1490/860/1990	1090/860/1990 +1490/860/1990	1090/860/1990 +1490/860/1990	1090/860/1990 +1490/860/1990	1090/860/1990 +1490/860/1990	1490/860/1990 +1490/860/1990	1490/860/1990 +1490/860/1990	1490/860/1990 +1490/860/1990	
	Net/Shipping weight	kg	240/255	240/255	360/378	360/378	368/386	480/510	480/510	600/633	600/633	608/641	728/756	728/764	736/772	840/888	848/896	968/1011	968/1011	976/1027	1096/1150	1096/1150	1104/1158	
	Compressor type		DC INV SCROLL	DC INV SCROLL	DC INV SCROLL	DC INV SCROLL	DC INV SCROLL	DC INV SCROLL	DC INV SCROLL	DC INV SCROLL	DC INV SCROLL	DC INV SCROLL	DC INV SCROLL	DC INV SCROLL	DC INV SCROLL	DC INV SCROLL	DC INV SCROLL	DC INV SCROLL	DC INV SCROLL	DC INV SCROLL	DC INV SCROLL	DC INV SCROLL	DC INV SCROLL	
	Compressor brand		MTSUBISHI	MTSUBISHI	MTSUBISHI	MTSUBISHI	MTSUBISHI	MTSUBISHI	MTSUBISHI	MTSUBISHI	MTSUBISHI	MTSUBISHI	MTSUBISHI	MTSUBISHI	MTSUBISHI	MTSUBISHI	MTSUBISHI	MTSUBISHI	MTSUBISHI	MTSUBISHI	MTSUBISHI	MTSUBISHI	MTSUBISHI	
	Compressor quantity		1INV	1INV	1INV+1FX	1INV+1FX	1INV+1FX	1INV+1INV	1INV+1INV	1INV+1FX	1INV+1FX	1INV+1FX	1INV+1FX	1INV+1FX	1INV+1FX	1INV+1INV	1INV+1INV	1INV+1FX	1INV+1FX	1INV+1FX	1INV+1FX	1INV+1FX	1INV+1FX	
	Refrigerant type		R410A	R410A	R410A	R410A	R410A	R410A	R410A	R410A	R410A	R410A	R410A	R410A	R410A	R410A	R410A	R410A	R410A	R410A	R410A	R410A	R410A	
	Refrigerant charge	kg	10	11	12	12	14.5	21	22	25	25	25.5	26.5	26.5	29	34	36.5	37.5	40	41	41	43.5		
	Refrigerant liquid pipe	mm	9.52	9.52	12.7	12.7	12.7	15.88	15.88	15.88	15.88	19.05	19.05	19.05	19.05	19.05	19.05	19.05	19.05	19.05	19.05	19.05	19.05	
	Refrigerant gas pipe	mm	19.05	22.22	25.4	25.4	28.58	28.58	28.58	28.58	28.58	31.8	31.8	31.8	31.8	31.8	31.8	31.8	31.8	31.8	31.8	31.8	31.8	
Oil equalization pipe	mm	9.52	9.52	9.52	9.52	9.52	9.52	9.52	9.52	9.52	9.52	9.52	9.52	9.52	9.52	9.52	9.52	9.52	9.52	9.52	9.52	9.52		
Max pipe length	m	175	175	175	175	175	175	175	175	175	175	175	175	175	175	175	175	175	175	175	175	175		
Max drop between U/I & O/U	m	50	50	50	50	50	50	50	50	50	50	50	50	50	50	50	50	50	50	50	50	50		
External static pressure	Pa	50	50	50	50	50	50	50	50	50	50	50	50	50	50	50	50	50	50	50	50	50		
Connection ratio	Connectable indoor unit ratio	%	50-130	50-130	50-130	50-130	50-130	50-130	50-130	50-130	50-130	50-130	50-130	50-130	50-130	50-130	50-130	50-130	50-130	50-130	50-130	50-130		
	Maximum number of indoor units		13	16	19	23	26	29	33	36	39	43	46	50	53	56	59	63	64	64	64	64	64	
Working temp.	Cooling	°C	-5-43	-5-43	-5-43	-5-43	-5-43	-5-43	-5-43	-5-43	-5-43	-5-43	-5-43	-5-43	-5-43	-5-43	-5-43	-5-43	-5-43	-5-43	-5-43	-5-43		
	Heating	°C	-15-21	-15-21	-15-21	-15-21	-15-21	-15-21	-15-21	-15-21	-15-21	-15-21	-15-21	-15-21	-15-21	-15-21	-15-21	-15-21	-15-21	-15-21	-15-21	-15-21	-15-21	

\* All the specifications are tested under nominal condition in cooling. Indoor temp is 27°C DB/19°C WB. Outdoor temp 35°C DB/24°C WB. In heating, indoor temp is 20°C DB. Outdoor temp is 7°C DB/9°C WB.



## 4-WAY CASSETTE TYPE

- COMPACT DESIGN, ONLY 240MM HEIGHT, 700 x 700MM PANEL (For 2.8/3.6/4.5kW)

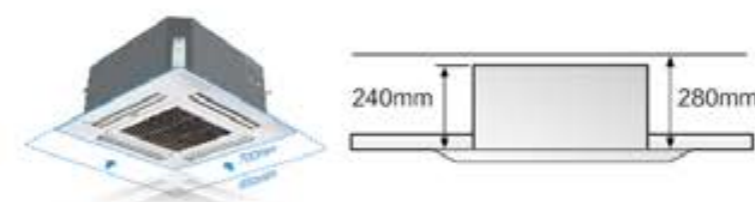

- QUIET OPERATION, DIFFUSER AND SPACE VORTEX FAN DESIGN, MORE LOWER NOISE

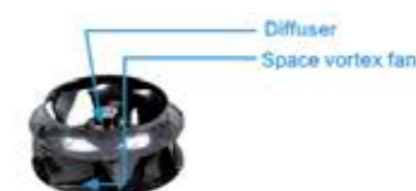

- BUILT IN HIGH HEAD DRAIN PUMP

- FRESH AIR INLET EXCEPT FOR 5.6/7.1/8.0 kW



# MRV III INDOOR

# 4-WAY CASSETTE TYPE



- AB092MCERA
- AB122MCERA
- AB162MCERA

- AB182MCERA
- AB242MCERA
- AB282MCERA

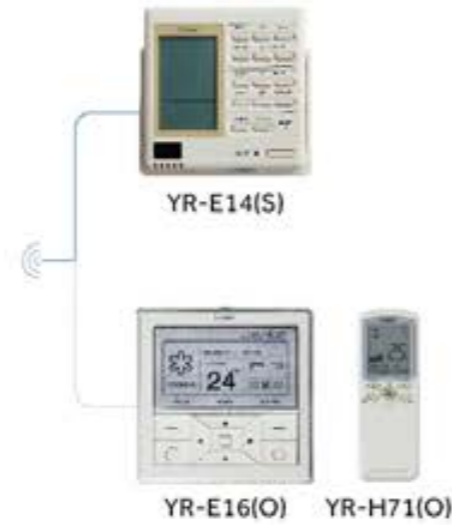

- On-Off card
- Group controller
- Central control
- Auto-swing
- 4-way airflow
- Clean air
- Auto restart
- 3 minutes protection
- 24 hours timer
- Low ambient cooling (-5°C)
- Low ambient heating (-5°C)
- Blue fin
- Low ambient heating
- Drain water pump

- On-Off card
- Group controller
- Central control
- Auto-swing
- 4-way airflow
- Clean air
- Auto restart
- 3 minutes protection
- 24 hours timer
- Low ambient cooling (-5°C)
- Low ambient heating (-5°C)
- Blue fin
- Low ambient heating
- Drain water pump

Model/Indoor unit		AB092MCERA	AB122MCERA	AB162MCERA
Capacity	Cooling	kBtu/h 9.5	12.6	15.3
	Heating	kW 2.8	3.6	4.5
Electrical	Power supply	PhV/Hz 1/220-230/50/60	1/220-230/50/60	1/220-230/50/60
	Air flow (l/h)	m³/h 700	700	700
Performance	Sound pressure level(H/M/L)	dB(A) 32/30/29	32/30/29	33/30/29
	Sound power level(H/M/L)	dB(A) 46/44/43	46/44/43	47/44/43
	External dimensions(W/D/H)	mm 570/570/260	570/570/260	570/570/260
Installation	Shipping dimensions(W/D/H)	mm 718/680/380	718/680/380	718/680/380
	Net/Shipping weight	kg 17/22	19/23.5	19/23.5
	Refrigerant liquid pipe	mm 6.35	6.35	6.35
	Refrigerant gas pipe	mm 9.52	12.7	12.7
Panel	Model name	PB-700B	PB-700B	PB-700B
	External dimensions(W/D/H)	mm 700/700/60	700/700/60	700/700/60
	Shipping dimensions(W/D/H)	mm 740/740/115	740/740/115	740/740/115
	Net/Shipping weight	kg 2.8/4.8	2.8/4.8	2.8/4.8
Controller	Wired(O—optional S—standard)	YR-E14(S)	YR-E14(S)	YR-E14(S)
		YR-E16(O)	YR-E16(O)	YR-E16(O)
	Infrared(O—optional S—standard)	YR-H71(O)	YR-H71(O)	YR-H71(O)

Model/Indoor unit		AB182MCERA	AB242MCERA	AB282MCERA
Capacity	Cooling	kBtu/h 19.1	24.2	27.3
	Heating	kW 5.6	7.1	8
Electrical	Power supply	PhV/Hz 1/220-230/50/60	1/220-230/50/60	1/220-230/50/60
	Air flow (l/h)	m³/h 1200	1200	1200
Performance	Sound pressure level(H/M/L)	dB(A) 34/32/30	35/34/31	37/35/31
	Sound power level(H/M/L)	dB(A) 48/46/44	49/48/45	51/49/45
	External dimensions(W/D/H)	mm 840/840/240	840/840/240	840/840/240
Installation	Shipping dimensions(W/D/H)	mm 930/930/330	930/930/330	930/930/330
	Net/Shipping weight	kg 30/32.5	30/32.5	30/32.5
	Refrigerant liquid pipe	mm 6.35	9.52	9.52
	Refrigerant gas pipe	mm 12.7	15.88	15.88
Panel	Model name	PB-950B	PB-950B	PB-950B
	External dimensions(W/D/H)	mm 950/950/80	950/950/80	950/950/80
	Shipping dimensions(W/D/H)	mm 992/992/115	992/992/115	992/992/115
	Net/Shipping weight	kg 6/9	6/9	6/9
Controller	Wired(O—optional S—standard)	YR-E14(S)	YR-E14(S)	YR-E14(S)
		YR-E16(O)	YR-E16(O)	YR-E16(O)
	Infrared(O—optional S—standard)	YR-H71(O)	YR-H71(O)	YR-H71(O)

# 4-WAY CASSETTE TYPE

- AB302MCERA
- AB382MCERA
- AB482MCERA

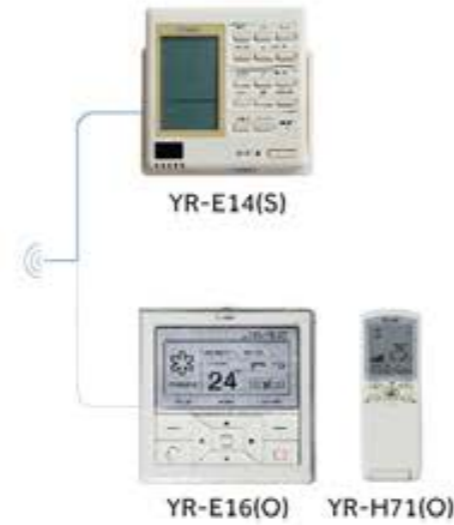

- On-Off card
- Group controller
- Central control
- Auto-swing
- 4-way airflow
- Clean air
- Auto restart
- 3 minutes protection
- 24 hours timer
- Low ambient cooling (-5°C)
- Low ambient heating (-5°C)
- Blue fin
- Low ambient heating
- Drain water pump

Model/Indoor unit		AB302MCERA	AB382MCERA	AB482MCERA	
Capacity	Cooling	kBtu/h 9	30.7 11.2	38.2 14	
	Heating	Btu/h kW	34.1 10	42.6 12.5	54.6 16
Electrical	Power supply	PhV/Hz	1/220-230/50/60	1/220-230/50/60	1/220-230/50/60
	Air flow (l/h)	m <sup>3</sup> /h	1800	1800	1800
Performance	Sound pressure level (M/L)	dB(A)	37/35/31	37/35/31	42/39/35
	Sound power level (M/L)	dB(A)	51/49/45	51/49/45	56/53/49
Installation	External dimensions (W/D/H)	mm	840/840/295	840/840/295	840/840/295
	Shipping dimensions (W/D/H)	mm	930/930/390	930/930/390	930/930/390
	Net/Shipping weight	kg	38/40	38/40	38/40
	Refrigerant liquid pipe	mm	9.52	9.52	9.52
Panel	Refrigerant gas pipe	mm	15.88	15.88	15.88
	Model name		PB-950JB	PB-950JB	PB-950JB
	External dimensions (W/D/H)	mm	950/950/80	950/950/80	950/950/80
	Shipping dimensions (W/D/H)	mm	992/992/115	992/992/115	985/985/115
Controller	Net/Shipping weight	kg	6/9	6/9	6/9
	Wired (O - optional, S - standard)		YR-E14(S) YR-E16(O)	YR-E14(S) YR-E16(O)	YR-E14(S) YR-E16(O)
	Infrared (O - optional, S - standard)		YR-H71(O)	YR-H71(O)	YR-H71(O)



# 2-WAY CASSETTE TYPE

COMPACT DESIGN: ONLY 260MM HEIGHT

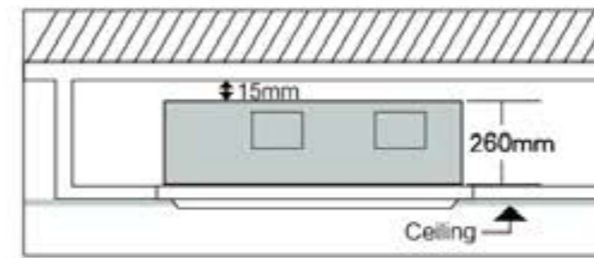

BUILT IN HIGH HEAD DRAIN PUMP



CEILING ANTIFOULING DESIGN  
UNIQUE ANTIFOULING DESIGN

TWO WAY AIR FLOW

QUIET OPERATION

5 MODELS RANGING FROM 2.8kW TO 5.6kW

# 2-WAY CASSETTE TYPE

- AB072MBERA
- AB092MBERA
- AB122MBERA
- AB162MBERA
- AB182MBERA

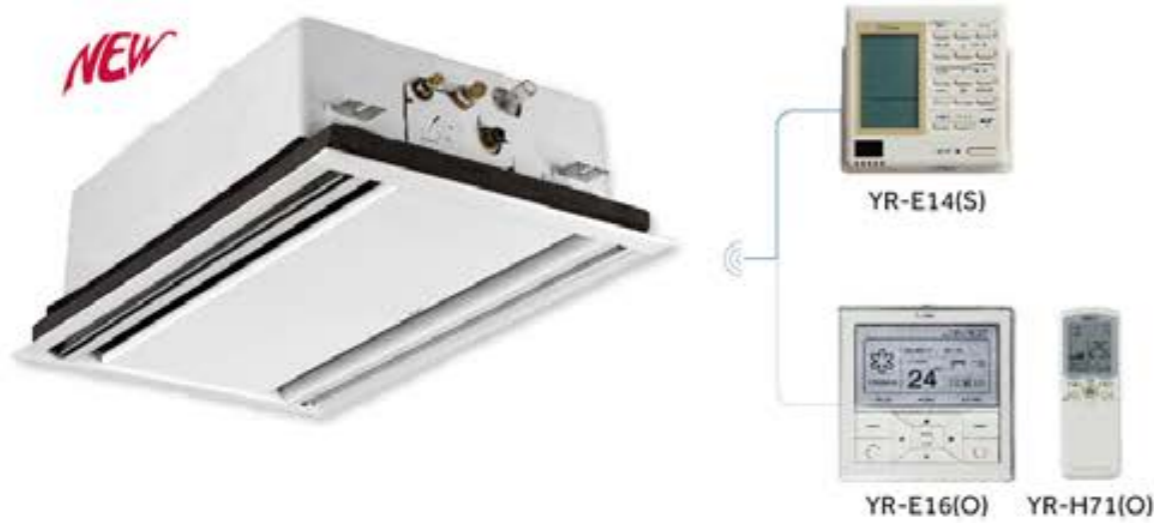

**CONVERTIBLE**  
TYPE

COMPACT DESIGN,  
ULTRA THIN UNIT BODY  
199MM (LESS THAN 24k Btu MODEL)

QUIET OPERATION

WIDE RANGE ANGLE AIR FLOW

ACTIVE CARBON AND ESF  
FILTER OPTIONAL

NEW STYLISH DESIGN FOR 8.0/9.0kW

9 MODELS RANGING FROM 2.8kW TO 14kW



Model/Indoor unit		AB072MBERA	AB092MBERA	AB122MBERA	AB162MBERA	AB182MBERA
Capacity	Cooling	kBtu/h	7.5	9.5	12.3	15.3
		kW	2.2	2.8	3.6	4.5
Capacity	Heating	Btu/h	8.5	10.9	13.6	17.1
		kW	2.5	3.2	4	5
Electrical	Power supply	PhV/Hz	1/220-230/50/60	1/220-230/50/60	1/220-230/50/60	1/220-230/50/60
Performance	Air flow (l/h)	m <sup>3</sup> /h	840	840	840	840
	Sound pressure level(H/M/L)	dB(A)	42/37/33	42/37/33	42/37/33	44/39/34
	Sound power level(H/M/L)	dB(A)	55/50/46	55/50/46	55/50/46	57/52/47
Installation	External dimensions(W/D/H)	mm	817/620/260	817/620/260	817/620/260	817/620/260
	Shipping dimensions(W/D/H)	mm	1015/695/278	1015/695/278	1015/695/278	1015/695/278
	Net/Shipping weight	kg	21/25	21/25	21/25	21/25
	Refrigerant liquid pipe	mm	6.35	6.35	6.35	6.35
	Refrigerant gas pipe	mm	9.52	9.52	12.7	12.7
Panel	Model name		P2B-1055B	P2B-1055B	P2B-1055B	P2B-1055B
	External dimensions(W/D/H)	mm	1055/680/8	1055/680/8	1055/680/8	1055/680/8
	Shipping dimensions(W/D/H)	mm	1110/720/161	1110/720/161	1110/720/161	1110/720/161
	Net/Shipping weight	kg	7/8	7/8	7/8	7/8
Controller	Wired(O-optional,S-standard)		YR-E14(S)	YR-E14(S)	YR-E14(S)	YR-E14(S)
			YR-E16(O)	YR-E16(O)	YR-E16(O)	YR-E16(O)
	Infrared(O-optional,S-standard)		YR-H71(O)	YR-H71(O)	YR-H71(O)	YR-H71(O)

# CONVERTIBLE TYPE



- AC092MCERA
- AC122MCERA
- AC162MCERA
- AC182MCERA
- AC242MCERA

- AC282MEERA
- AC302MEERA



- On-Off card
- Group controller
- Central control
- Left/Right air-flow
- Auto-swing
- Clean air
- Auto restart
- 3 minutes protection
- 24 hours timer
- Low ambient cooling (-15°C)
- Low ambient heating (-15°C)
- Blue fin
- Low ambient heating

- On-Off card
- Group controller
- Central control
- Left/Right air-flow
- Auto-swing
- Clean air
- Auto restart
- 3 minutes protection
- 24 hours timer
- Compact design
- Low ambient cooling (-15°C)
- Low ambient heating (-15°C)
- Blue fin
- Low ambient heating

Model/Indoor unit			AC092MCERA	AC122MCERA	AC162MCERA	AC182MCERA	AC242MCERA
Capacity	Cooling	kBtu/h	9	12.3	15.4	19.1	24.2
		kW	2.8	3.6	4.5	5.6	7.1
	Heating	Btu/h	13	13.6	17.1	21.5	27.3
		kW	3.2	4	5	6.3	8
Electrical	Power supply	Ph/V/Hz	1/220-230/50/60	1/220-230/50/60	1/220-230/50/60	1/220-230/50/60	1/220-230/50/60
Performance	Air flow (H)	m³/h	800	800	800	800	800
	Sound pressure level (M/L)	dB(A)	38/35/33	38/35/33	40/37/35	40/37/35	40/37/35
	Sound power level (M/L)	dB(A)	51/48/46	51/48/46	53/50/48	53/50/48	53/50/48
Installation	External dimensions (W/D/H)	mm	990/665/199	990/665/199	990/665/199	990/665/199	990/665/199
	Shipping dimensions (W/D/H)	mm	1150/750/300	1150/750/300	1150/750/300	1150/750/300	1150/750/300
	Net/Shipping weight	kg	28.3/34.3	28.3/34.3	28.3/34.3	28.3/34.3	28.3/34.3
	Refrigerant liquid pipe	mm	6.35	6.35	6.35	6.35	9.52
	Refrigerant gas pipe	mm	9.52	12.7	12.7	12.7	15.88
Controller	Wired (O - optional S - standard)		YR-E14(S)	YR-E14(S)	YR-E14(S)	YR-E14(S)	YR-E14(S)
			YR-E16(O)	YR-E16(O)	YR-E16(O)	YR-E16(O)	YR-E16(O)
	Infrared (O - optional S - standard)		YR-H71(O)	YR-H71(O)	YR-H71(O)	YR-H71(O)	YR-H71(O)

Model/Indoor unit			AC282MEERA	AC302MEERA
Capacity	Cooling	kBtu/h	27.3	30.7
		kW	8	9
	Heating	Btu/h	30.7	34.1
		kW	9	10
Electrical	Power supply	Ph/V/Hz	1/220-230/50/60	1/220-230/50/60
Performance	Air flow (H)	m³/h	1500	1500
	Sound pressure level (M/L)	dB(A)	43/40/38	43/40/38
	Sound power level (M/L)	dB(A)	56/53/51	56/53/51
Installation	External dimensions (W/D/H)	mm	1298/700/240	1298/700/240
	Shipping dimensions (W/D/H)	mm	1500/790/315	1500/790/315
	Net/Shipping weight	kg	38/45	38/45
	Refrigerant liquid pipe	mm	9.52	9.52
	Refrigerant gas pipe	mm	15.88	15.88
Controller	Wired (O - optional S - standard)		YR-E14(S)	YR-E14(S)
			YR-E16(O)	YR-E16(O)
	Infrared (O - optional S - standard)		YR-H71(O)	YR-H71(O)

- AC382MFERA
- AC482MFERA



**DUCT**  
Slim Low ESP



185MM HEIGHT ULTRA THIN DESIGN AND 420MM DEPTH

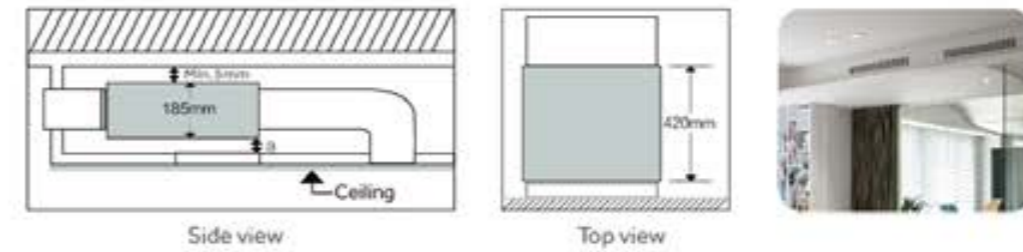

BUILT IN DRAIN PUMP

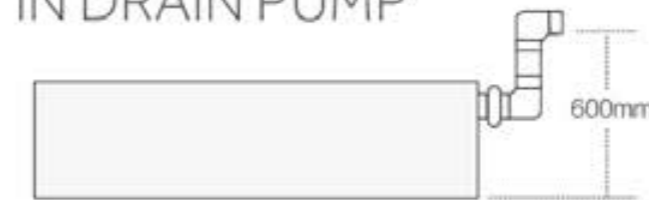

ULTRA LOW NOISE :  
REALIZE 21 dB(A) OPERATION NOISE

REAR AIR RETURN

STATIC PRESSURE 0~30Pa

6 MODELS RANGING FROM 2.2kW TO 7.1kW

- On-Off card
- Group controller
- Central control
- Left/right airflow
- Auto-swing
- Clean air
- Auto restart
- 3 minutes protection
- 24 hours timer
- Compact design
- Low ambient cooling (5°C)
- Low ambient heating (15°C)
- Blue Fin
- Low ambient heating

Model/Indoor unit		AC382MFERA	AC482MFERA
Capacity	Cooling	kBtu/h 11.2	48 14
	Heating	Btu/h 42.6	54 16
Electrical	Power supply	Ph/V/Hz	1/220-230/50/60
	Air flow (H)	m³/h	2040
Performance	Sound pressure level (M/L)	dB(A)	46/42/38
	Sound power level (M/L)	dB(A)	59/55/51
Installation	External dimensions (W/D/H)	mm	1580/700/240
	Shipping dimensions (W/D/H)	mm	1710/790/315
Controller	Net/Shipping weight	kg	54/61
	Refrigerant liquid pipe	mm	9.52
Controller	Refrigerant gas pipe	mm	15.88
	Wired (O - optional, S - standard)		YR-E14(S) YR-E16(O) YR-H71(O)
Controller	Infrared (O - optional, S - standard)		YR-E14(S) YR-E16(O) YR-H71(O)

# DUCT Slim Low ESP(0~30Pa)

- AD072MSERA
- AD092MSERA
- AD122MSERA
- AD162MSERA

- AD182MSERA
- AD242MSERA



- On-Off card
- Group controller
- Central control
- Clean air
- Auto restart
- 3 minutes protection
- 24 hours timer
- Compact design
- Low ambient cooling 18°C
- Low ambient heating 18°C
- Blue fin
- Low ambient heating
- Drain water pump

- On-Off card
- Group controller
- Central control
- Clean air
- Auto restart
- 3 minutes protection
- 24 hours timer
- Compact design
- Low ambient cooling 18°C
- Low ambient heating 18°C
- Blue fin
- Low ambient heating
- Drain water pump

Model/Indoor unit			AD072MSERA	AD092MSERA	AD122MSERA	AD162MSERA
Capacity	Cooling	kBtu/h	7.5	9.5	12.3	15.3
		kW	2.2	2.8	3.6	4.5
Capacity	Heating	Btu/h	8.5	10.9	13.6	17.1
		kW	2.5	3.2	4	5
Electrical	Power supply	Ph/V/Hz	1/220-230/50/60	1/220-230/50/60	1/220-230/50/60	1/220-230/50/60
Performance	Air flow (H)	m <sup>3</sup> /h	480	480	600	640
	Sound pressure level(H/M/L)	dB(A)	30/26/21	30/26/21	32/29/26	34/31/29
	Sound power level(H/M/L)	dB(A)	44/40/35	44/40/35	46/43/40	48/45/43
Installation	External dimensions(W/D/H)	mm	850/420/185	850/420/185	850/420/185	850/420/185
	Shipping dimensions(W/D/H)	mm	1025/525/260	1025/525/260	1025/525/260	1025/525/260
	Net/Shipping weight	kg	15/16	15/16	17/18	19/20
	Refrigerant liquid pipe	mm	6.35	6.35	6.35	6.35
	Refrigerant gas pipe	mm	9.52	9.52	12.7	12.7
Controller	Static pressure	Pa	0-30	0-30	0-30	0-30
	Wired(O-optional S-standard)		YR-E14(S)	YR-E14(S)	YR-E14(S)	YR-E14(S)
Controller	Infrared(O-optional S-standard)		YR-E16(O)	YR-E16(O)	YR-E16(O)	YR-E16(O)
	Infrared(O-optional S-standard)		YR-H71(O)	YR-H71(O)	YR-H71(O)	YR-H71(O)
Drain pump	S-standard		S	S	S	S

Model/Indoor unit			AD182MSERA	AD242MSERA
Capacity	Cooling	kBtu/h	19.1	24.2
		kW	5.6	7.1
Capacity	Heating	Btu/h	21.5	27.3
		kW	6.3	8
Electrical	Power supply	Ph/V/Hz	1/220-230/50/60	1/220-230/50/60
Performance	Air flow (H)	m <sup>3</sup> /h	930	960
	Sound pressure level(H/M/L)	dB(A)	35/32/30	35/32/30
	Sound power level(H/M/L)	dB(A)	49/46/44	49/46/44
Installation	External dimensions(W/D/H)	mm	1170/420/185	1170/420/185
	Shipping dimensions(W/D/H)	mm	1345/525/260	1345/525/260
	Net/Shipping weight	kg	25/26.5	27/28.5
	Refrigerant liquid pipe	mm	6.35	9.52
	Refrigerant gas pipe	mm	12.7	15.88
Controller	Static Pressure	Pa	0-30	0-30
	Wired(O-optional S-standard)		YR-E14(S)	YR-E14(S)
Controller	Infrared(O-optional S-standard)		YR-E16(O)	YR-E16(O)
	Infrared(O-optional S-standard)		YR-H71(O)	YR-H71(O)
Drain Pump	S-standard		S	S

# DUCT

Low ESP(0~30Pa)



# DUCT Low ESP(0~30Pa)

- AD072MLERA
- AD092MLERA
- AD122MLERA

- 220MM HEIGHT ULTRA THIN DESIGN
- OPTIONAL EXTERNAL DRAIN PUMP
- BOTTOM OR REAR AIR RETURN
- STATIC PRESSURE 0/20Pa
- 6 MODELS RANGING FROM 2.2kW TO 7.1kW



- On-Off card
- Group control
- Central control
- Clean air
- Auto restart
- 3 min protection
- 24 hours timer
- Low ambient cooling (5°C)
- Low ambient heating (15°C)
- Blue fin
- Low ambient heating

Model/Indoor unit			AD072MLERA	AD092MLERA	AD122MLERA
Capacity	Cooling	NBtu/h	7.5	9.5	12.3
	Heating	Btu/h	2.2	2.8	3.6
Electrical	Power supply	PhV/V/Hz	1/220-230/50/60	1/220-230/50/60	1/220-230/50/60
	Air flow (H)	m <sup>3</sup> /h	400	400	500
Performance	Sound pressure level(H/M/L)	dB(A)	35/32/30	35/32/30	35/32/30
	Sound power level(H/M/L)	dB(A)	49/46/44	49/46/44	49/46/44
	External dimensions(W/D/H)	mm	610/484/220	610/484/220	610/484/220
Installation	Shipping dimensions(W/D/H)	mm	710/545/280	710/545/280	710/545/280
	Net/Shipping weight	kg	15/17	15/17	16/18
	Refrigerant liquid pipe	mm	6.35	6.35	6.35
	Refrigerant gas pipe	mm	9.52	9.52	12.7
	Static pressure	Pa	0/20	0/20	0/20
	Controller	Wired(O-optional/S-standard)		YR-E14(S)	YR-E14(S)
Infrared(O-optional/S-standard)			YR-E16(O)	YR-E16(O)	YR-E16(O)
			YR-H71(O)	YR-H71(O)	YR-H71(O)

# DUCT Low ESP(0~30Pa)

- AD162MLERA
- AD182MLERA
- AD242MLERA



- On-Off card
- Group control
- Central control
- Clean air
- Auto-restart
- 3 minutes protection
- 24 hours timer
- Low ambient cooling 14°C
- Low ambient heating 14°C
- Blue fin
- Low ambient heating

Model/Indoor unit			AD162MLERA	AD182MLERA	AD242MLERA
Capacity	Cooling	kBtu/h	15.3	19.1	24.2
		kW	4.5	5.6	7.1
	Heating	Btu/h	17.1	21.5	27.3
		kW	5	6.3	8
Electrical	Power supply	PhV/Hz	1/220-230/50/60	1/220-230/50/60	1/220-230/50/60
	Air flow (l/h)	m³/h	850	1250	1250
Performance	Sound pressure level (M/L)	dB(A)	35/32/30	39/37/35	39/37/35
	Sound power level (M/L)	dB(A)	49/46/44	53/51/49	53/51/49
Installation	External dimensions (W/D/H)	mm	1090/484/220	1090/484/220	1090/484/220
	Shipping dimensions (W/D/H)	mm	1174/545/280	1174/545/280	1174/545/280
	Net/Shipping weight	kg	19/20	25/26.5	27/28.5
	Refrigerant liquid pipe	mm	6.35	6.35	9.52
	Refrigerant gas pipe	mm	12.7	12.7	15.88
Controller	Static pressure	Pa	0/20	0/20	0/20
	Wired (O - optional, S - standard)		YR-E14(S)	YR-E14(S)	YR-E14(S)
			YR-E16(O)	YR-E16(O)	YR-E16(O)
	Infrared (O - optional, S - standard)		YR-H71(O)	YR-H71(O)	YR-H71(O)



# DUCT Medium ESP (50~96Pa)

BUILT IN DRAIN PUMP

FLEXIBLE DUCT CONNECTION

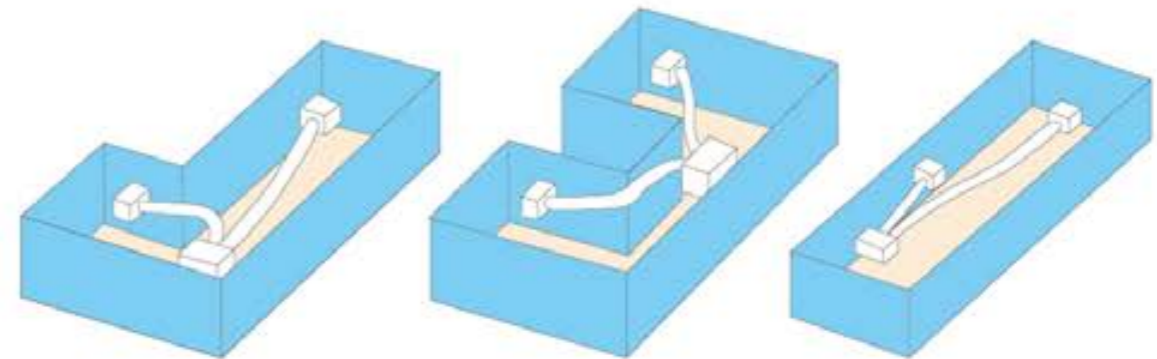

STATIC PRESSURE 50~96Pa

6 MODELS RANGING FROM 5.6kW TO 14kW

# DUCT Medium ESP(50~96Pa)



- AD182MMERA
- AD242MMERA
- AD282MMERA

- AD302MMERA
- AD382MMERA
- AD482MMERA



- On-Off card
- Group controller
- Central control
- Clean air
- Auto restart
- 3 minutes protection
- 24 hours timer
- Low ambient cooling <math>1^{\circ}\text{C}</math>
- Low ambient heating <math>1^{\circ}\text{C}</math>
- Blue fan
- Low ambient heating
- LED display

- On-Off card
- Group controller
- Central control
- Clean air
- Auto restart
- 3 minutes protection
- 24 hours timer
- Low ambient cooling <math>1^{\circ}\text{C}</math>
- Low ambient heating <math>1^{\circ}\text{C}</math>
- Blue fan
- Low ambient heating
- LED display

Model/Indoor unit			AD182MMERA	AD242MMERA	AD282MMERA
Capacity	Cooling	kBtu/h	19.1	24.2	27.3
		kW	5.6	7.1	8
Capacity	Heating	Btu/h	21.5	27.3	30.7
		kW	6.3	8	9
Electrical	Power supply	Ph/V/Hz	1/220-230/50/60	1/220-230/50/60	1/220-230/50/60
Performance	Air flow (H)	m <sup>3</sup> /h	1200	1200	1200
	Sound pressure level(H/M/L)	dB(A)	36/34/31	36/34/31	39/37/35
	Sound power level(H/M/L)	dB(A)	49/47/44	49/47/44	52/50/48
	External dimensions(W/D/H)	mm	990/650/300	990/650/300	990/650/300
Installation	Shipping dimensions(W/D/H)	mm	1167/860/345	1167/860/345	1167/860/345
	Net/Shipping weight	kg	39/45	39/45	39/45
	Refrigerant liquid pipe	mm	6.35	9.52	9.52
	Refrigerant gas pipe	mm	12.7	15.88	15.88
	Static pressure	Pa	50-96	50-96	50-96
	Controller	Wired(O-optional S-standard)		YR-E14(S)	YR-E14(S)
	Infrared(O-optional S-standard)		YR-E16(O)	YR-E16(O)	YR-E16(O)
			YR-H71(O)	YR-H71(O)	YR-H71(O)
Drain pump	S-standard		S	S	S

Model/Indoor unit			AD302MMERA	AD382MMERA	AD482MMERA
Capacity	Cooling	kBtu/h	30.7	38.2	47.7
		kW	9	11.2	14
Capacity	Heating	Btu/h	34.1	42.6	54.6
		kW	10	12.5	16
Electrical	Power supply	Ph/V/Hz	1/220-230/50/60	1/220-230/50/60	1/220-230/50/60
Performance	Air flow (H)	m <sup>3</sup> /h	1900	1900	2100
	Sound pressure level(H/M/L)	dB(A)	39/37/35	41/40/39	41/40/39
	Sound power level(H/M/L)	dB(A)	52/50/48	54/53/52	54/53/52
	External dimensions(W/D/H)	mm	1410/645/350	1410/645/350	1410/645/350
Installation	Shipping dimensions(W/D/H)	mm	1557/800/370	1557/800/370	1557/800/370
	Net/Shipping weight	kg	59/66	59/66	59/66
	Refrigerant liquid pipe	mm	9.52	9.52	9.52
	Refrigerant gas pipe	mm	15.88	15.88	15.88
	Static pressure	Pa	50-96	50-96	50-96
	Controller	Wired(O-optional S-standard)		YR-E14(S)	YR-E14(S)
	Infrared(O-optional S-standard)		YR-E16(O)	YR-E16(O)	YR-E16(O)
			YR-H71(O)	YR-H71(O)	YR-H71(O)
Drain pump	S-standard		S	S	S

# DUCT

Medium ESP  
(80~120Pa)



# DUCT Medium ESP(80~120Pa)

- 🇧🇪 AD182MZERA
- 🇧🇪 AD242MZERA
- 🇧🇪 AD282MZERA

- NEW COMPACT DESIGN:  
(270mm height for 5.6/7.1/8.0kW)
- BUILT-IN DRAIN PUMP FOR 5.6/7.1/8.0kW
- OPTIONAL EXTERNAL DRAIN PUMP  
(FOR 9.0/11.2/14kW)
- FLEXIBLE DUCT CONNECTION



- STATIC PRESSURE 80~120Pa
- 6 MODELS RANGING FROM 5.6kW TO 14kW



- On-Off card
- Group control
- Central control
- Clean air
- Auto restart
- 3 min protection
- 24 hours timer
- Low ambient cooling 1-8°C
- Low ambient heating 1-13°C
- Blue fn
- Low ambient heating

Model/Indoor unit			AD182MZERA	AD242MZERA	AD282MZERA
Capacity	Cooling	kBtu/h	19.1	24.2	27.3
		kW	5.6	7.1	8
Capacity	Heating	Btu/h	21.5	27.3	30.7
		kW	6.3	8	9
Electrical	Power supply	PV/V/Hz	1/220-230/50/60	1/220-230/50/60	1/220-230/50/60
	Air flow (H)	m³/h	950	950	950
Performance	Sound pressure level(H/M/L)	dB(A)	44/42/39	44/42/39	44/42/39
	Sound power level(H/M/L)	dB(A)	57/55/52	57/55/52	57/55/52
	External dimensions(W/D/H)	mm	950/650/270	950/650/270	950/650/270
Installation	Shipping dimensions(W/D/H)	mm	1170/860/340	1170/860/340	1170/860/340
	Net/Shipping weight	kg	37/39	37/39	37/39
	Refrigerant liquid pipe	mm	6.35	9.52	9.52
	Refrigerant gas pipe	mm	12.7	15.88	15.88
	Static pressure (Standard)	Pa	80	80	80
	Static pressure(Max)	Pa	120	120	120
	Controller	Wired(O-optional,S-standard)		YR-E14(S) YR-E16(O)	YR-E14(S) YR-E16(O)
Drain pump	Infrared(O-optional,S-standard) S-standard		YR-H71(O) S	YR-H71(O) S	YR-H71(O) S

# DUCT Medium ESP(80~120Pa)

- AD302MNERA
- AD382MNERA
- AD482MNERA

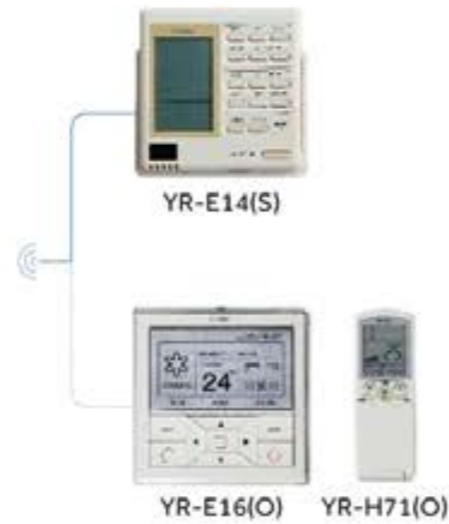

# DUCT High ESP (100~196Pa)

VARIABLE STATIC PRESSURE  
100~196Pa SETTING

FLEXIBLE DUCT CONNECTION

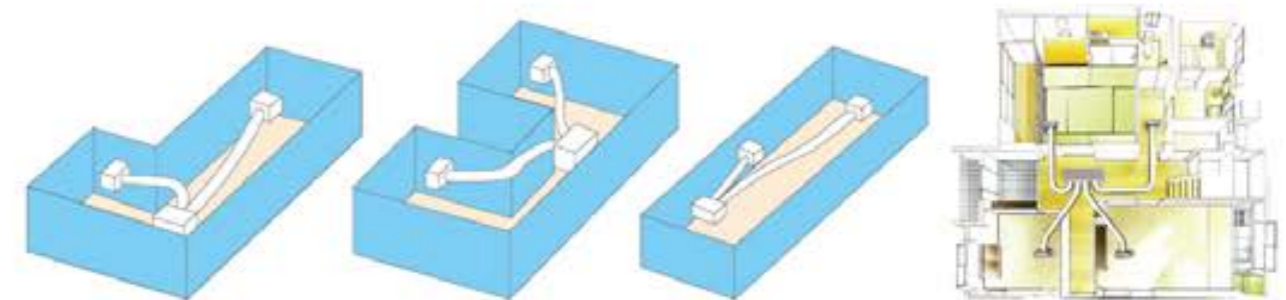

8 MODELS RANGING FROM 5.6kW TO 28kW

- On-Off card
- Group control
- Control control
- Clean air
- Auto restart
- 3 min protection
- 24 hours timer
- Low ambient cooling 14°C
- Low ambient heating 14°C
- Blue Air
- Low ambient heating

Model/Indoor unit			AD302MNERA	AD382MNERA	AD482MNERA
Capacity	Cooling	kBtu/h	30	38	48
	Heating	kW	9	11.2	14
Electrical	Power supply	Phi/V/Hz	1/220-230/50/60	1/220-230/50/60	1/220-230/50/60
	Air flow (H)	m <sup>3</sup> /h	1800	1800	1800
Performance	Sound pressure level(L/M/L)	dB(A)	49/47/45	49/47/45	49/47/45
	Sound power level(L/M/L)	dB(A)	62/60/56	62/60/56	62/60/56
Installation	External dimensions(W/D/H)	mm	1135/742/270	1135/742/270	1135/742/270
	Shipping dimensions(W/D/H)	mm	1300/820/325	1300/820/325	1300/820/325
	Net/Shipping weight	kg	50/53	50/53	50/53
	Refrigerant liquid pipe	mm	9.52	9.52	9.52
	Refrigerant gas pipe	mm	15.88	15.88	15.88
	Static pressure (Standard)	Pa	80	80	80
Controller	Static pressure(Max)	Pa	120	120	120
	Wired(O--optional,S--standard)		YR-E14(S)	YR-E14(S)	YR-E14(S)
			YR-E16(O)	YR-E16(O)	YR-E16(O)
	Infrared(O--optional,S--standard)		YR-H71(O)	YR-H71(O)	YR-H71(O)

# DUCT High ESP(100~196Pa)



- AD182MHERA
- AD242MHERA
- AD282MHERA

- AD302MHERA
- AD382MHERA
- AD482MHERA

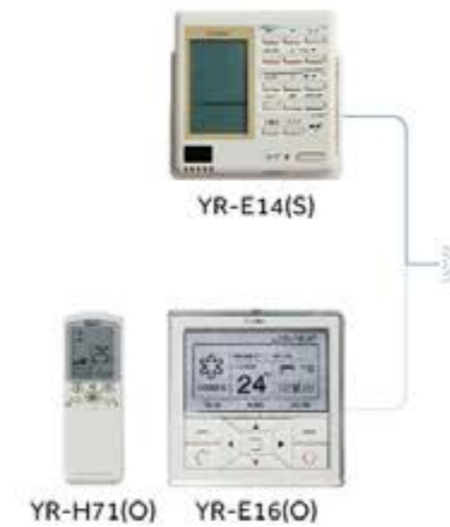
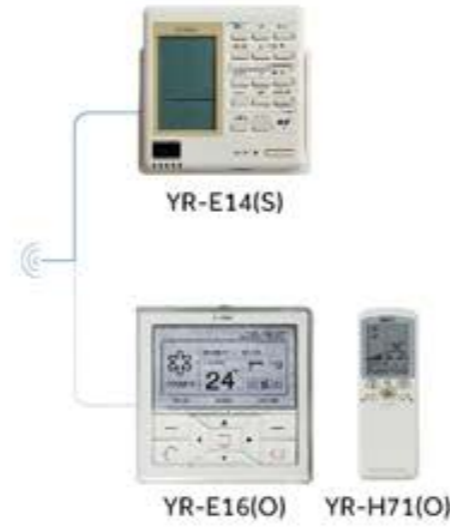

- AD722MHERA
- AD962MHERA



- On-Off card
- Group controller
- Central control
- Clean air
- Auto restart
- 3 minutes protection
- 24 hours timer
- Low ambient cooling 14°C
- Low ambient heating 14°C
- Blue Air
- Low ambient heating

- On-Off card
- Group controller
- Central control
- Clean air
- Auto restart
- 3 minutes protection
- 24 hours timer
- Low ambient cooling 14°C
- Low ambient heating 14°C
- Blue Air
- Low ambient heating

Model/Indoor unit			AD182MHERA	AD242MHERA	AD282MHERA
Capacity	Cooling	kBtu/h	19.1	24.2	27.3
	Heating	kW	5.6	7.1	8
Electrical	Power supply	Ph/V/Hz	1/220-230/50/60	1/220-230/50/60	1/220-230/50/60
	Air flow (l/s)	m <sup>3</sup> /h	1500	1500	1500
Performance	Sound pressure level(H/M/L)	dB(A)	46/42/40	46/42/40	46/42/40
	Sound power level(H/M/L)	dB(A)	59/55/53	59/55/53	59/55/53
Installation	External dimensions(W/D/H)	mm	970/875/360	970/875/360	970/875/360
	Shipping dimensions(W/D/H)	mm	1051/940/510	1051/940/510	1051/940/510
	Net/Shipping weight	kg	48/58	48/58	48/58
	Refrigerant liquid pipe	mm	6.35	9.52	9.52
	Refrigerant gas pipe	mm	12.7	15.88	15.88
	Static pressure (Standard)	Pa	100	100	100
	Static pressure(Max)	Pa	196	196	196
Controller	Wired(O-optional,S-standard)		YR-E14(S)	YR-E14(S)	YR-E14(S)
	Infrared(O-optional,S-standard)		YR-E16(O)	YR-E16(O)	YR-E16(O)
			YR-H71(O)	YR-H71(O)	YR-H71(O)

Model/Indoor unit			AD302MHERA	AD382MHERA	AD482MHERA	AD722MHERA	AD962MHERA
Capacity	Cooling	kBtu/h	30.7	38.2	47.7	77.1	95.5
	Heating	kW	9	11.2	14	22.6	28
Electrical	Power supply	Ph/V/Hz	1/220-230/50/60	1/220-230/50/60	1/220-230/50/60	1/220-230/50/60	1/220-230/50/60
	Air flow (l/s)	m <sup>3</sup> /h	1560	1600	2100	4050	4050
Performance	Sound pressure level(H/M/L)	dB(A)	50/46/44	50/46/44	50/46/44	54/49/45	54/49/45
	Sound power level(H/M/L)	dB(A)	63/59/57	63/59/57	63/59/57	67/62/58	67/62/58
Installation	External dimensions(W/D/H)	mm	1197/830/360	1197/830/360	1197/830/360	1570/880/360	1570/880/360
	Shipping dimensions(W/D/H)	mm	1430/940/400	1430/940/400	1430/940/400	1800/1000/525	1800/1000/525
	Net/Shipping weight	kg	62/77	62/77	62/77	92/100	92/100
	Refrigerant liquid pipe	mm	9.52	9.52	9.52	9.52	9.52
	Refrigerant gas pipe	mm	15.88	15.88	15.88	25.4	25.4
	Static pressure (Standard)	Pa	100	100	100	100	100
	Static pressure(Max)	Pa	196	196	196	196	196
Controller	Wired(O-optional,S-standard)		YR-E14(S)	YR-E14(S)	YR-E14(S)	YR-E14(S)	YR-E14(S)
	Infrared(O-optional,S-standard)		YR-E16(O)	YR-E16(O)	YR-E16(O)	YR-E16(O)	YR-E16(O)
			YR-H71(O)	YR-H71(O)	YR-H71(O)	YR-H71(O)	YR-H71(O)



- AD482MPERA
- AD722MPERA
- AD962MPERA

- INSTALL WITH OTHER INDOOR UNITS TOGETHER, AND INTRODUCE THE OUTDOOR FRESH AIR INTO INDOOR
- VARIABLE STATIC PRESSURE 100~196Pa SETTING
- OPERATION RANGE -5~43°C
- 3 MODELS RANGING FROM 14kW TO 28kW

**Realize the air conditioning and fresh air function in the same system**

- > New fresh air unit connection capacity must be less than 30% of the capacity of the outdoor unit.
- > 80% outdoor capacity ≤ the total connection capacity (air conditioning unit + fresh air unit) ≤ 100% outdoor capacity.
- > The fresh air unit can not be used in the air conditioning condition.

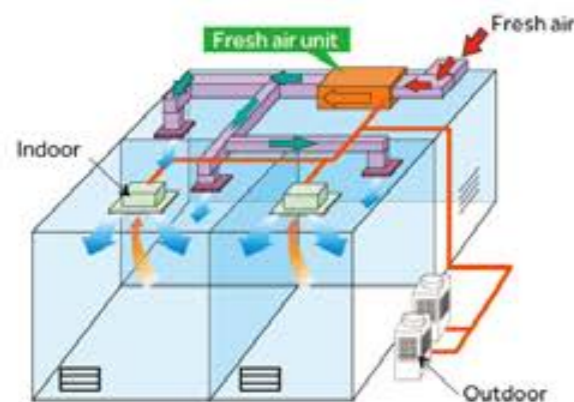
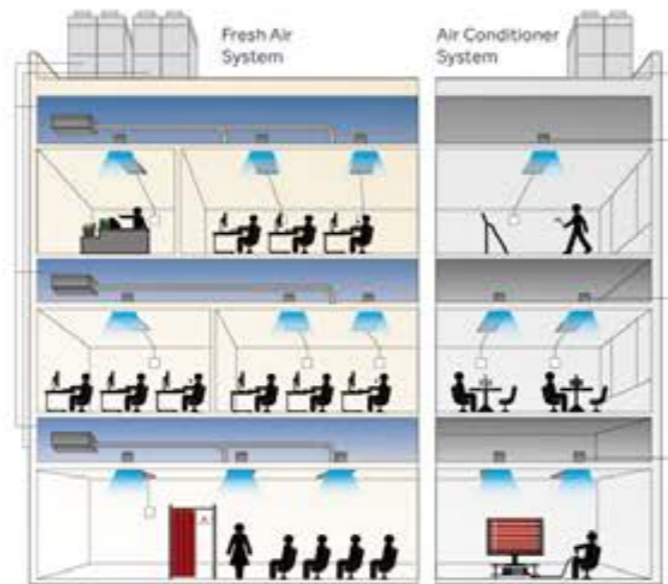

- On-Off card
- Group controller
- Control control
- Clean air
- Auto restart
- 3 minutes protection
- 24 hours timer
- Low ambient cooling (LACC)
- Low ambient heating (LASH)
- Blue Fin

Model/Indoor unit		AD482MPERA	AD722MPERA	AD962MPERA	
Capacity	Cooling	kBtu/h	47.7	77.1	95.5
	Heating	Btu/h	14	22.6	28
Electrical	Power supply	Ph/V/Hz	1/220-230/50	1/220-230/50	1/220-230/50
	Air flow (H)	m <sup>3</sup> /h	1600	2300	2800
Performance	Sound pressure level(H/M/L)	dB(A)	50/46/44	54/49/45	54/49/45
	Sound power level(H/M/L)	dB(A)	63/59/57	67/62/58	67/62/58
	External dimensions(W/D/H)	mm	1197/830/360	1570/880/360	1570/880/360
Installation	Shipping dimensions(W/D/H)	mm	1430/940/420	1800/1000/525	1800/1000/525
	Net/Shipping weight	kg	62/77	120/140	120/140
	Refrigerant liquid pipe	mm	9.52	9.52	9.52
	Refrigerant gas pipe	mm	15.88	25.4	25.4
	Static pressure	Pa	100-196	100-196	100-196
Controller	Wired(O-optional,S-standard)		YR-E14(S)	YR-E14(S)	YR-E14(S)
	Infrared(O-optional,S-standard)		YR-E16(O)	YR-E16(O)	YR-E16(O)
			YR-H71(O)	YR-H71(O)	YR-H71(O)

# Built-in Floor Standing



# Built-in Floor Standing

- 🇨🇦 AE072MLERA
- 🇨🇦 AE162MLERA
- 🇨🇦 AE092MLERA
- 🇨🇦 AE182MLERA
- 🇨🇦 AE122MLERA
- 🇨🇦 AE242MLERA

- GOOD SOLUTION FOR INSTALLATION BENEATH A WINDOW
- THE BODY IS CONCEALED IN THE COVER (To Get A Good Decoration Effect)
- HIGH EFFICIENCY FILTER FITTED AS STANDARD
- REQUIRE VERY LITTLE INSTALLATION SPACE: ONLY 220MM

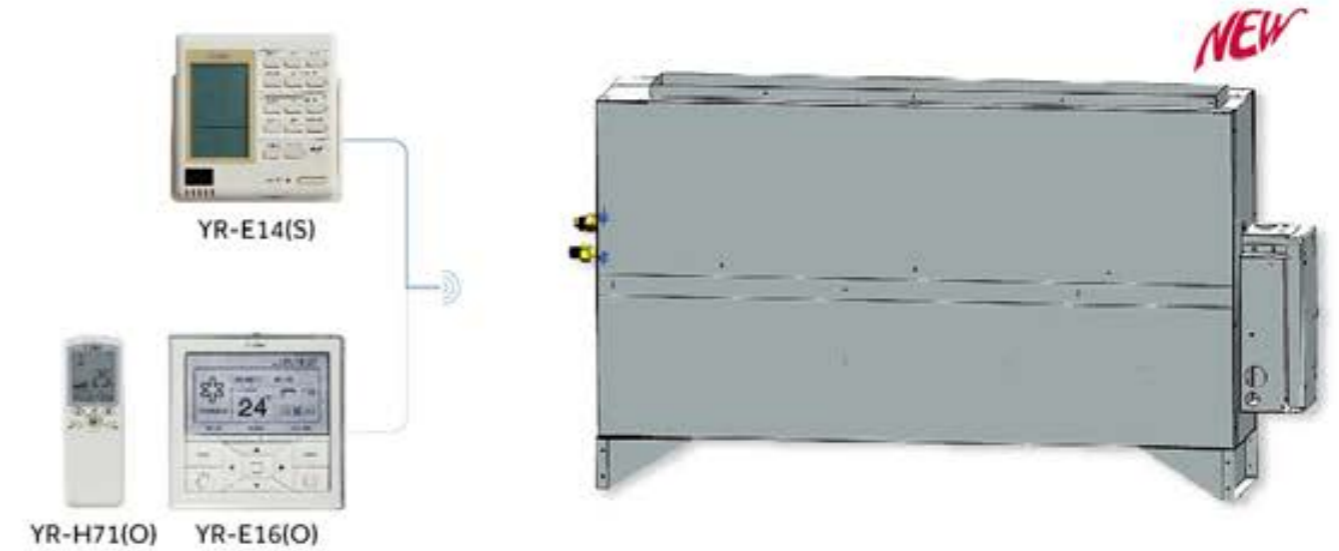

- 6 MODELS RANGING FROM 2.2kW TO 7.1kW

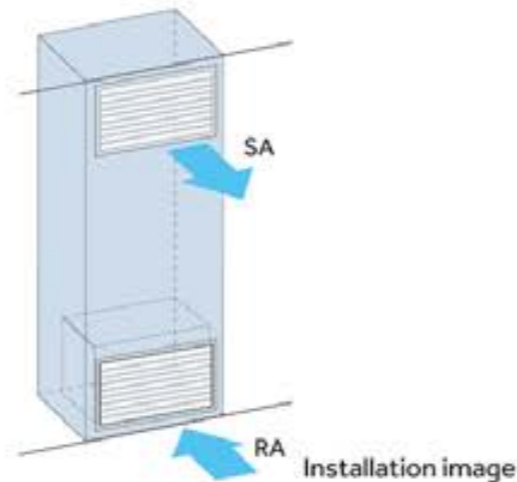

- 🇨🇦 On-Off card
- 🇨🇦 Central control
- 🇨🇦 Auto-swing
- 🇨🇦 Clean air
- 🇨🇦 Auto restart
- 🇨🇦 3 min protection
- 🇨🇦 24 hours timer
- 🇨🇦 Compact design
- 🇨🇦 Low ambient cooling 1-15°C
- 🇨🇦 Low ambient heating 1-15°C
- 🇨🇦 Blue fin
- 🇨🇦 Low ambient heating

Model/Indoor unit			AE072MLERA	AE092MLERA	AE122MLERA	AE162MLERA	AE182MLERA	AE242MLERA
Capacity	Cooling	kBtu/h	7.5	9.5	12.3	15.3	19.1	24.2
	Heating	kBtu/h	2.2	2.8	3.6	4.5	5.6	7.1
Electrical	Power supply	PhV/Hz	1/220-230/50/60	1/220-230/50/60	1/220-230/50/60	1/220-230/50/60	1/220-230/50/60	1/220-230/50/60
	Air flow (H)	m <sup>3</sup> /h	800	800	800	800	800	800
	Performance	Sound pressure level(H/M/L)	dB(A)	38/35/33	38/35/33	40/37/35	40/37/35	42/39/36
Installation	Sound power level(H/M/L)	dB(A)	51/48/46	51/48/46	53/50/48	53/50/48	55/52/49	55/52/49
	External dimensions(W/D/H)	mm	995/635/220	995/635/220	995/635/220	995/635/220	995/635/220	995/635/220
	Shipping dimensions(W/D/H)	mm	1095/735/272	1095/735/272	1095/735/272	1095/735/272	1095/735/272	1095/735/272
	Net/Shipping weight	kg	32/35	32/35	32/35	32/35	32/35	32/35
	Refrigerant liquid pipe	mm	6.35	6.35	6.35	6.35	6.35	9.52
Controller	Refrigerant gas pipe	mm	9.52	9.52	12.7	12.7	12.7	15.88
	Static Pressure	Pa	30	30	30	30	30	30
	Wired(O-optional,S-standard)		YR-E14(S)	YR-E14(S)	YR-E14(S)	YR-E14(S)	YR-E14(S)	YR-E14(S)
Controller	Infrared(O-optional,S-standard)		YR-E16(O)	YR-E16(O)	YR-E16(O)	YR-E16(O)	YR-E16(O)	YR-E16(O)
			YR-H71(O)	YR-H71(O)	YR-H71(O)	YR-H71(O)	YR-H71(O)	YR-H71(O)





# Console

TYPE



# Console

TYPE

 AF072MAERA     AF122MAERA  
 AF092MAERA     AF182MAERA

■ COMPACT DESIGN & SMALL SPACE OCCUPATION

■ QUIET OPERATION

■ AIR DISCHARGE THROUGH TOP(COOLING) OR BOTTOM(HEATING)

■ 4 MODELS RANGING FROM 2.2kW TO 5.6kW



Model/Indoor unit			AF072MAERA	AF092MAERA	AF122MAERA	AF182MAERA
Capacity	Cooling	kBtu/h	7.5	9.5	12.3	17
		kW	2.2	2.8	3.6	5.6
Capacity	Heating	Btu/h	8.5	10.9	13.6	20.5
		kW	2.5	3.2	4	6
Electrical	Power supply	Ph/V/Hz	1/220-230/50/60	1/220-230/50/60	1/220-230/50/60	1/220-230/50/60
	Air flow (l)	m <sup>3</sup> /h	460	460	520	580
Performance	Sound pressure level(H/M/L)	dB(A)	43/39/36	43/39/36	43/39/36	43/39/36
	Sound power level(H/M/L)	dB(A)	56/53/49	56/53/49	56/53/49	56/53/49
Installation	External dimensions(W/D/H)	mm	720/253/640	720/253/640	720/253/640	720/253/640
	Shipping dimensions(W/D/H)	mm	784/305/719	784/305/719	784/305/719	784/305/719
Installation	Net/Shipping weight	kg	18/20	18/20	18/20	18/20
	Refrigerant liquid pipe	mm	6.35	6.35	6.35	6.35
	Refrigerant gas pipe	mm	12.7	12.7	12.7	12.7
Controller	Wired(O-optional,S-standard)		/	/	/	/
	Infrared(O-optional,S-standard)		YR-H71(S)	YR-H71(S)	YR-H71(S)	YR-H71(S)

# High Wall EEV Inside



# High Wall EEV Inside

- AS072MGERA
- AS162MGERA
- AS092MGERA
- AS182MGERA
- AS122MGERA
- AS242MGERA

STYLISH DESIGN & LED DISPLAY

BUILT IN EEV,  
Easy to Installation

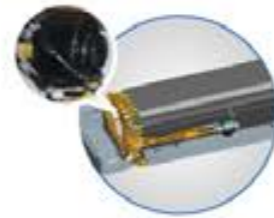

DC FAN MOTOR AND NOT EQUIDISTANT  
CROSS FLOW FAN: Reduce Noise and  
Create A Comfortable Environment



NEGATIVE ION, VITAMIN C, AND ESF FILTER OPTIONAL

6 MODELS RANGING FROM 2.2kW TO 7.1kW



Model/Indoor unit			AS072MGERA	AS092MGERA	AS122MGERA	AS162MGERA	AS182MGERA	AS242MGERA
Capacity	Cooling	kBtu/h	7.5	9.5	12.3	15.3	19.1	24.2
		kW	2.2	2.8	3.6	4.5	5.6	7.1
	Heating	Btu/h	8.5	10.9	13.6	17.1	21.5	27.3
		kW	2.5	3.2	4	5	6.3	8
Electrical	Power supply	Ph/V/Hz	1/220-230/50/60	1/220-230/50/60	1/220-230/50/60	1/220-230/50/60	1/220-230/50/60	1/220-230/50/60
Performance	Air flow (l/s)	m <sup>3</sup> /h	600	600	600	600	800	800
	Sound pressure level(H/M/L)	dB(A)	37/33/31	37/34/31	41/36/33	41/36/33	43/39/34	48/39/37
	Sound power level(H/M/L)	dB(A)	48/44/42	48/45/42	52/47/44	52/47/44	54/50/45	59/50/48
	External dimensions(W/D/H)	mm	938/187/265	938/187/265	938/187/265	938/187/265	1046/234/299	1046/234/299
Installation	Shipping dimensions(W/D/H)	mm	1016/304/360	1016/304/360	1016/304/360	1016/304/360	1126/344/388	1126/344/388
	Net/Shipping weight	kg	10.9/12.6	10.9/12.6	10.9/12.6	10.9/12.6	15/16.5	13/16.5
	Refrigerant liquid pipe	mm	6.35	6.35	6.35	6.35	9.52	9.52
	Refrigerant gas pipe	mm	12.7	12.7	12.7	12.7	15.88	15.88
Controller	Wired(O-optional,S-standard)		/	/	/	/	/	/
	Infrared(O-optional,S-standard)		YR-H71(S)	YR-H71(S)	YR-H71(S)	YR-H71(S)	YR-H71(S)	YR-H71(S)

# HRV

## Heat Reclaim Ventilation



# HRV

- ERV0150ANN
- ERV0260ANN
- ERV0800ANN
- ERV1000ANN

- EFFICIENT HEAT RECOVERY AIR PROCESSING
- HEAT RECOVERY MEDIA ELEMENT
- BE CONTROLLED WITH OTHER INDOOR UNITS TOGETHER

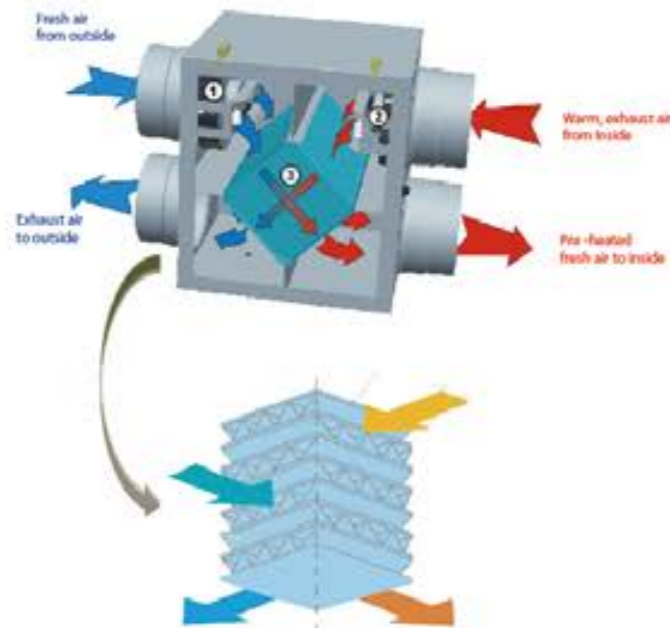

- Central control
- Qynfresh
- Clean air
- Auto restart
- 3 minutes protection
- 24 hours timer

■ 4 MODELS RANGING  
From 150CMH to 1000CMH

Model/Indoor unit			ERV0150ANN	ERV0260ANN	ERV0800ANN	ERV1000ANN
Electrical	Power supply	Ph/V/Hz	1/220-230/50/60	1/220-230/50/60	1/220-230/50/60	1/220-230/50/60
	Rated power input	kW	0.1	0.12	0.36	0.36
Performance	Rated current	A	0.55	0.55	1.65	1.65
	Air flow (H)	m <sup>3</sup> /h	150	260	800	1000
	Sound pressure level (H/M/L)	dB(A)	44/43/43/38	44/43/43/38	57/55/56/52	57/55/56/52
Installation	External dimensions (W/D/H)	mm	940/685/276	940/685/276	1227/1115/387	1227/1115/387
	Shipping dimensions (W/D/H)	mm	1013/773/345	1013/773/345	1465/1213/430	1465/1213/430
	Net/Shipping weight	kg	28.7/31.2	28.7/31.2	85.5/90.6	85.5/90.6
	Static pressure	Pa	80	60	120	100
Controller	Wired (O=optional, S=standard)		YR-N04(S)	YR-N04(S)	YR-N04(S)	YR-N04(S)
	Infrared (O=optional, S=standard)		/	/	/	/

# CONTROL SYSTEM



# Control System

Controller & BMS	Design	Model	Functions	For what units
Touch screen central controller		YCZ-A003	<ul style="list-style-type: none"> <li>*Single unit control</li> <li>*Central control, max. 128 units</li> <li>*Weekly timer</li> <li>*Zone control</li> <li>*Can be connected the third party interface: modbus rtu</li> <li>*Max. 32 IGU05 units can be connected with one YCZ-A003</li> </ul>	All
Wired controller		YR-E16	<ul style="list-style-type: none"> <li>*Single unit control</li> <li>*Group control, max 16 units</li> <li>*Weekly timer</li> <li>*Clock</li> <li>*Mode: cooling, heating, auto, air flow, dehumidification</li> <li>*Temperature, fan speed, fan direction</li> </ul>	Cassette Convertible Duct type Built-in floor standing
Wired controller		YR-E14	<ul style="list-style-type: none"> <li>*Single unit control</li> <li>*Group control, max 16 units</li> <li>*Clock</li> <li>*Timer</li> <li>*Mode: cooling, heating, auto, air flow, dehumidification</li> <li>*Temperature, fan speed, fan direction</li> </ul>	Cassette Convertible Duct type Built-in floor standing
Infrared controller		YR-H71	<ul style="list-style-type: none"> <li>*Single unit operation</li> <li>*Clock</li> <li>*Timer</li> <li>*Mode: cooling, heating, auto, air flow, dehumidification</li> <li>*Sleep setting</li> <li>*Child lock</li> </ul>	Wall mounted Console type(Optional controller for cassette, Convertible Duct type
Wireless control receiver		RE-02	Realize infrared control for duct type	Duct
Simple controller		YR-F02	<ul style="list-style-type: none"> <li>*Single unit control</li> <li>*Group control, max 16 units</li> </ul>	Cassette Convertible Duct type

Controller & BMS	Design	Model	Functions	For what units
Remote monitoring version3 BMS system: IPC(Industrial personal computer) + software		HCM-03	<ul style="list-style-type: none"> <li>*Max. 4 groups system; Every system can connect max. 20 IGU02 units; Every IGU02 can connect max. 40 indoor units</li> <li>*Total connected indoor units quantity is max. 1000</li> <li>*On/off, fan speed, temperature control</li> <li>*Operation mode control</li> <li>*Schedule timer (weekly, monthly)</li> <li>*Electricity charge report</li> <li>*Interface: BACnet ip, Modbus ip, Modbus rtu</li> <li>*Many users remote monitoring</li> <li>*History record and curve</li> </ul>	All
Local control version BMS system: (RS485&232 converter+software)		HCM-01	<ul style="list-style-type: none"> <li>*Max. 32 IGU02 units to be connected</li> <li>*Max. 40 indoor units connected for every system</li> <li>*Total connected indoor units quantity is Max. 400</li> <li>*On/off, fan speed, temperature control</li> <li>*Operation mode control</li> <li>*Schedule timer (weekly, monthly)</li> <li>*Modbus rtu interface (only display, without control)</li> <li>*Electricity charge report</li> </ul>	All
Gateway		IGU02	<ul style="list-style-type: none"> <li>*Match with HCM-01, HCM-03</li> <li>*Every system need one IGU02</li> <li>*Max. 40 indoor units connected for every IGU02</li> <li>*Protocol adapter</li> <li>*Electricity charge data collection, calculation, allocation and storage</li> </ul>	All
Gateway		IGU05	<ul style="list-style-type: none"> <li>*Match with YCZ-A003</li> <li>*Every system need one IGU05</li> </ul>	All
Modbus Gateway		IGU06	<ul style="list-style-type: none"> <li>Modbus rtu</li> <li>*Connect the outdoor unit to change the homebus protocol to modbus protocol</li> <li>*And then match with the IGU07 to realize the Lonworks gateway function</li> </ul>	All
Lonworks Gateway		IGU07	<ul style="list-style-type: none"> <li>Lonworks protocol gateway</li> <li>*Every outdoor system adopt one IGU07+IGU06</li> <li>*In one system, total connected indoor units quantity is Max. 32</li> <li>*The Longate need connect external 24V DC power supply</li> </ul>	All

## YR-E16



### USER FRIENDLY-DESIGN

- > 4.3 inch big TFT-LCD screen
- > Backlight design
- > Cross keys, easy to operate
- > The large fonts and user-friendly interface, fashion and taking into operation for the elderly

### USER FRIENDLY-FUNCTION

- > Built in weekly timer function: When a power failure occurs, all settings remain stored up to 72 hours
- > Mode memory function
- > Energy saving and the child lock function, to meet the individual needs of different places and populations
- > Wired control and group control, Max.16 indoor units

### USER FRIENDLY-INSTALLATION

- > Push-pull structure
- > Using plug interface to fix the connection wire without screw, easy installation without tools



## Central Controller 【YCZ-A003 + IGU05】

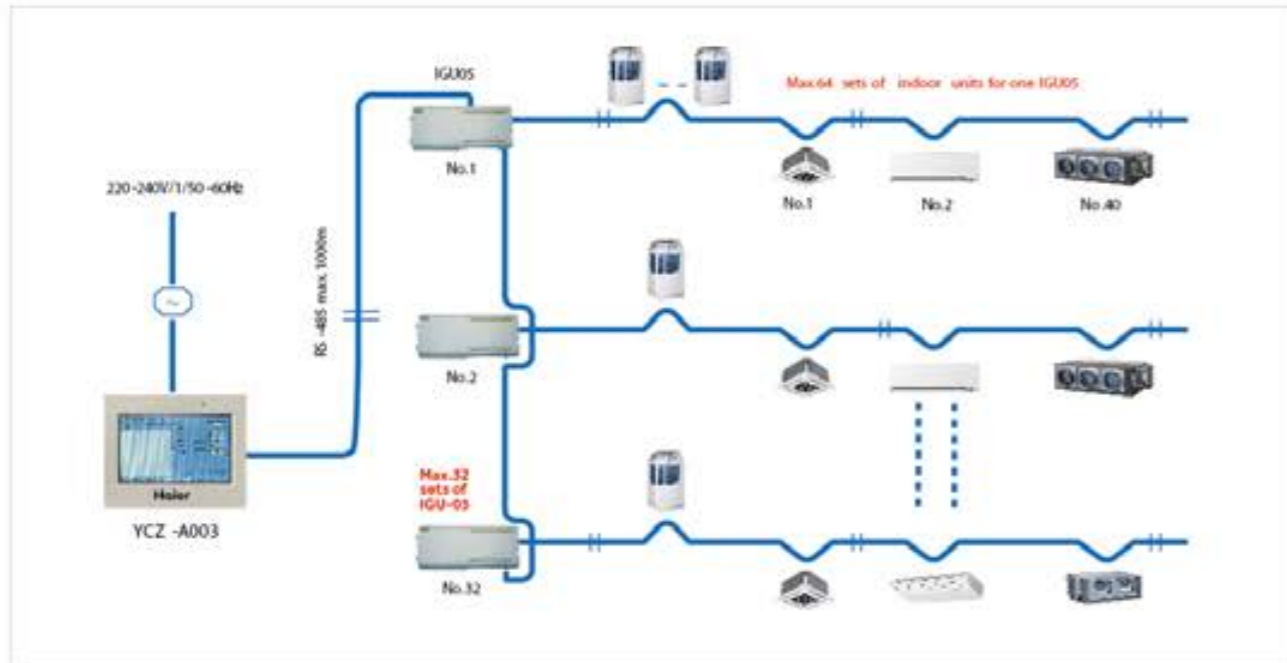

## Smart A/C Management 【HCM-01 + IGU02】

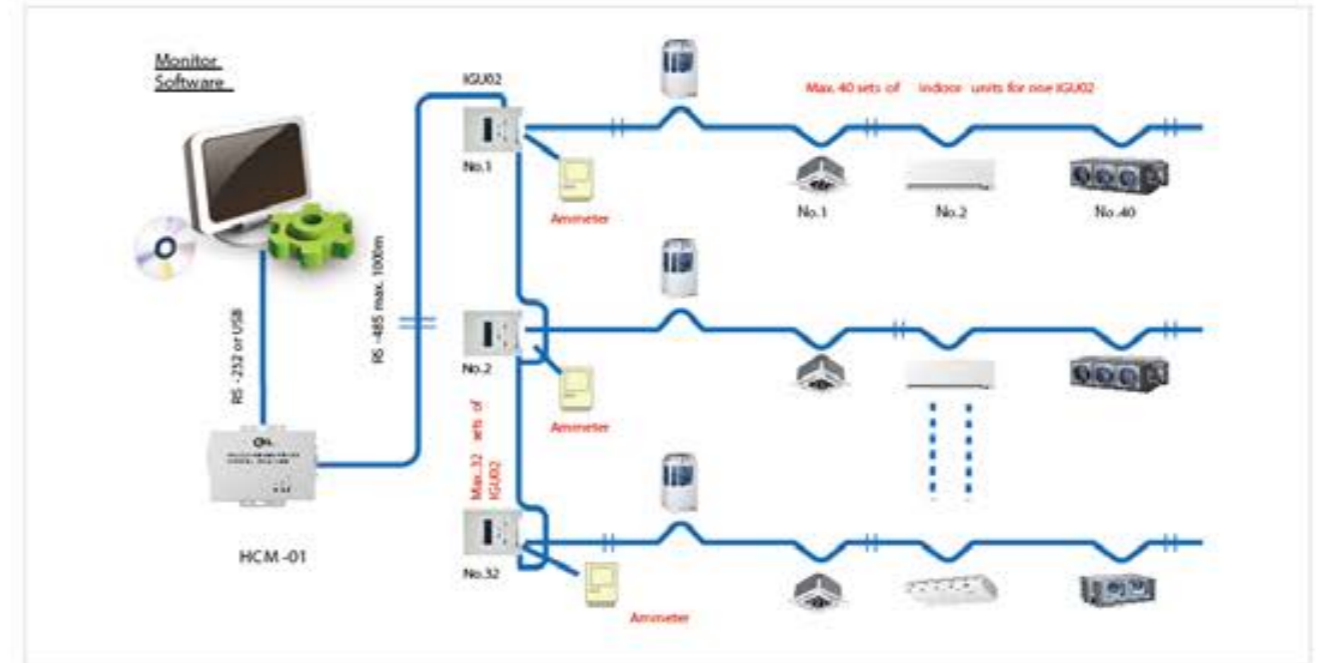

## BAC net A/C Management 【HCM-03 + IGU02】

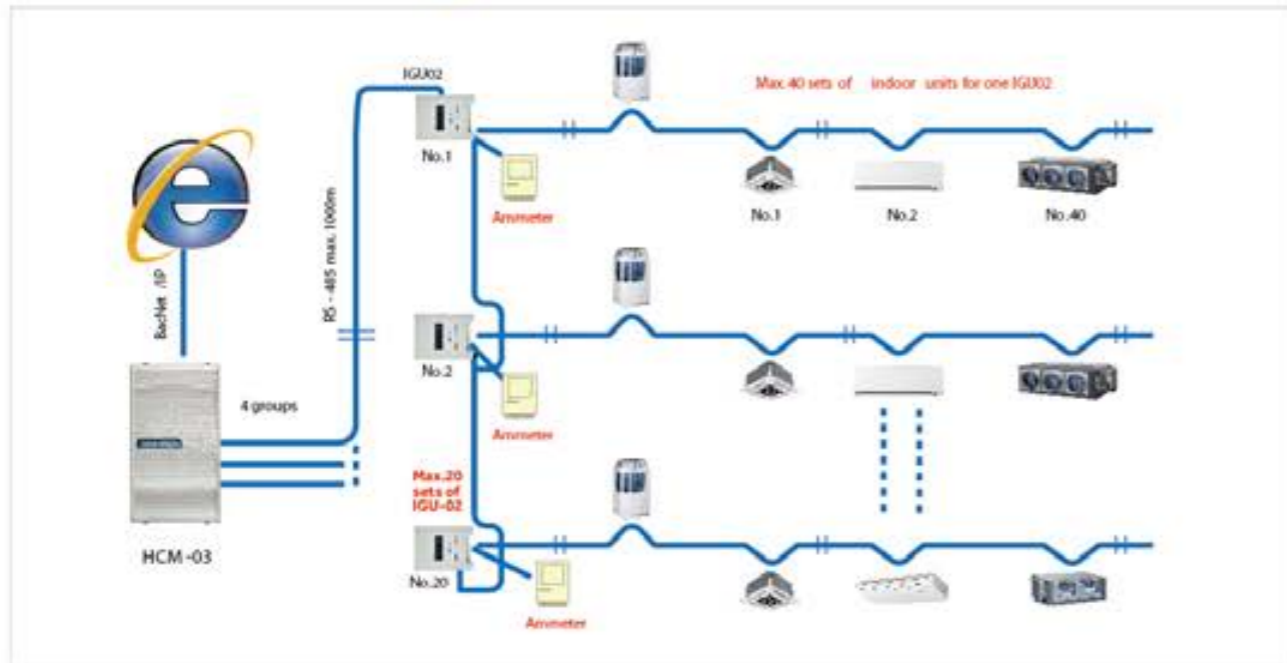



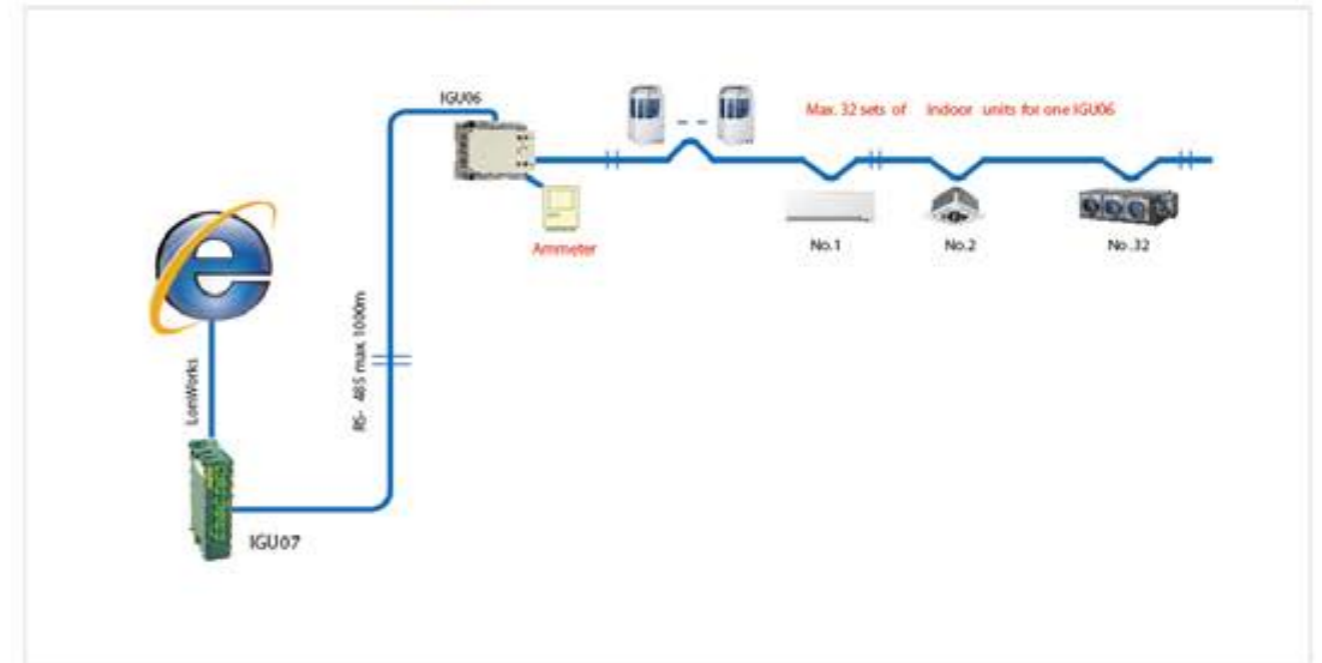



## Lon works Gateway 【IGU07 + IGU06】



# ACCESSORIES



Name	Design	Model	Functions	For what units
Gather pipe		HZG-20A	Refrigerant gathering	2 models
Gather pipe		HZG-30A	Refrigerant gathering	3 models
Manifold pipe		FQG-B335A	Refrigerant distribution	Total indoor units capacity less than 33,500W
Manifold pipe		FQG-B506A	Refrigerant distribution	Total indoor units capacity less than 50,600W, but equal or bigger than 33,500W
Manifold pipe		FQG-B730A	Refrigerant distribution	Total indoor units capacity less than 73,000W, but equal or bigger than 50,600W
Manifold pipe		FQG-B1350A	Refrigerant distribution	Total indoor units capacity bigger than 73,000W

**Haier**  
Inspired living